

Pièces

DYNAMIC

070006268

By

VALCKE
GROUP



Introducing...

DYNAMIC

Cher technicien,

Bienvenue dans la première édition de notre catalogue de pièces Dynamic. Vous êtes nombreux à nous soutenir depuis dix ans. Durant ces années, nous avons vendu des pièces dans plus de 30 pays grâce à notre réseau de distributeurs. Ces pièces ont depuis perduré dans le temps grâce à leur qualité et leur solidité. C'est pourquoi nous sommes prêts à vous présenter notre nouvelle marque, DYNAMIC.

Merci de nous rejoindre dans cette aventure.

Vous êtes nos experts sur le terrain.

Sans votre travail mettant nos produits à l'épreuve, nous n'aurions pas l'occasion de nous challenger, de faire la différence sur les performances de nos pièces, les temps d'arrêt de la machine, les augmentations d'intervalles d'entretien et la satisfaction de votre clientèle.

Vous êtes notre plus grand atout!

Partagez vos commentaires et idées à venir, nous sommes impatients de travailler en étroite collaboration avec vous pendant de nombreuses années.

L'équipe DYNAMIC et Valcke Group

Comment obtenir le meilleur de ce catalogue...

Ce catalogue a été conçu pour faciliter le travail des techniciens. Les produits sont classés en catégories allant de l'avant à l'arrière de votre poseur de quilles.

Tout ce que nous faisons est fait par des techniciens pour des techniciens. Vous ne trouverez pas de catégories « Kickback » mais ces pièces sont bien présentes avec les autres catégories « Cushion », « Pit » et « PBL » (Ball Lift).

Ce que vous voyez est ce que vous recevrez !

Pour votre tranquillité, nous avons pris une photo de toutes les pièces présentes dans ce catalogue. Aucune surprise, vous commandez la pièce dont vous avez besoin et vous recevez ce que vous avez commandé.

Les pièces bénéficiant du symbole  sont de meilleure qualité que les pièces d'origine.

Les coordonnées de votre distributeur se trouvent à l'arrière de ce catalogue. Nous collaborons avec les meilleurs experts dans le monde du bowling, ils sont nos yeux et nos oreilles dans votre secteur.

N'hésitez pas à les contacter si vous avez la moindre question.

DBOWLING.COM

Introduction	1
Tools	✓
Special Tools	✓
Section 1	
Sweep	1.1
Sweep Bar & Arm Assemblies	1.1
Section 2	
Front End.....	2.1
Front End Drive Assemblies.....	2.1
Spot & Respot Tie Rod Assemblies.....	2.2
Section 3	
Bin & Shuttle	3.1
Bin Assembly.....	3.1
Shuttle & Solenoid	3.4
Section 4	
Table.....	4.1
Table Assembly	4.1
Yoke & Bearing Assembly.....	4.5
Table Torque Tube Assembly	4.8
Table Wireway Assembly.....	4.9
Respot Cell Assembly	4.11
Section 5	
Distributor.....	5.1
Distributor Assembly	5.1
Distributive Drive Assemblies 70's.....	5.9
Distributive Drive Assemblies 90's.....	5.10

Section 6	Ball Lift	6.1
	Ball Lift (PBL)	6.1
	Ball Tensioner & Belt Tightener	6.4
	Light Ball Sensor	6.6
	Ratchet Drive Assembly	6.10
	Old Style Kicker Ball Lift	6.12
	Track Rail Assembly	6.13
Section 7	Back End	7.1
	Pit Area	7.1
	Cushion Assembly	7.5
	Pin Wheel Assembly 70's	7.8
	Pin Wheel Assembly 90's	7.10
Section 8	Front of House	8.1
	Bumper Assembly	8.1
	Ball Return	8.3
Section 9	Hardware	9.1
	Distribution Network	VI

SPECIAL TOOLS

Tools for AMF Pinspotters

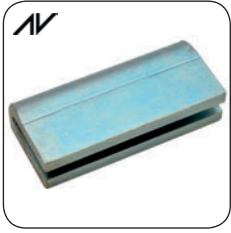

000-027-647



030-003-943



070-006-038



070-006-519



610-600-000



784-003-000



792-501-001



792-502-002



792-505-005



845-100-000SP

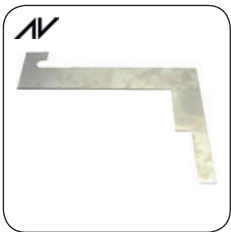

T0002

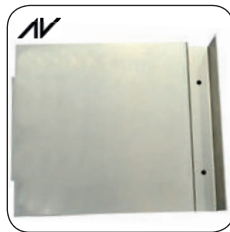

T0003



T0004



090-005-425

Tools for AMF Pinspotters

000-027-647	Front Roller Safety Tool - Tool AV	784-003-050	Flag Tool Handle - Tool
030-003-943	Crank Handle - Tool	792-501-001	Carpet Removing Pin - Tool
070-006-038	Belt Lacing Tool - Tool	792-502-002	Carpet Flag - Tool
070-006-519	Respot Gauge - Tool	792-505-005	Spring Puller Hook - Tool
T0004	Guide 90ST Table Setting Gauge	845-100-000SP	Giant Spanner AV
090-005-425	Steel Table Locating Tool	T0002	Table Setting 'Suffolk' Gauge J AV
610-600-000	PBL Vise Holder - Tool AV	T0003	Table Setting 'Suffolk' Gauge R AV
784-003-000	Rivet & Carpet Install Tool - Front Roller & Cushion		

SWEEP BAR AND ARM ASSEMBLIES

Pinspotter Parts for AMF Equipment



000-021-527



000-022-811



000-022-811T



000-023-104



000-023-105



000-023-114



000-023-160
000-023-161



000-023-182N

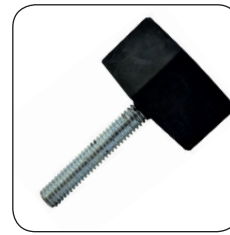

000-023-216



000-025-004
000-025-005



070-003-103



070-003-106



070-003-117



070-003-158



070-003-159



070-003-162



070-003-173



070-003-184



070-003-189



070-003-190
070-003-191



070-003-195



070-003-221



070-003-222



070-003-223



070-003-231

SWEEP BAR AND ARM ASSEMBLIES

Pinspotter Parts for AMF Equipment



070-003-232



070-003-233



070-003-234



070-003-235



070-003-238



070-003-242



070-003-243



070-006-121

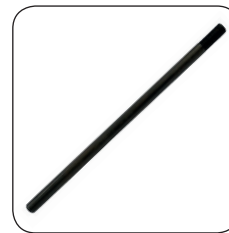

070-007-276



070-007-278



070-007-280



070-007-281



070-007-282



070-007-283



090-003-906



090-003-907



090-005-257



090-005-260
090-005-261



090-006-128



090-006-136



300-000-170
300-000-171



300-000-170U



300-000-171U



300-000-182

DB - High Performance Bowling Parts

SWEEP BAR AND ARM ASSEMBLIES

Pinspotter Parts for AMF Equipment

000-021-527	Bolt - U - Sweep	090-001-170	Please refer to: 300-001-170U
000-022-811	Pillow Block - Table Torque Tube & Sweep	090-001-171	Please refer to: 300-001-171U
000-022-811T	Dura Pillow Block 	090-003-906	Fixed Rod End Asm - Sweep
000-023-104	Flange Bearing 1.25 x1.5 x.953 - Sweep	090-003-907	Link Casting
000-023-105	Sleeve Bushing .628 x .8150D x.396 - Sweep	090-005-257	Rod End 7/16 RH - Sweep
000-023-114	Flange Bearing .628 x .8155 x.06 - Sweep	090-005-260	Rod End RH 1/2 Male - Sweep
000-023-160	Rod End RH - Sweep	090-005-261	Rod End LH 1/2 Male - Sweep
000-023-161	Rod End LH - Sweep	090-006-128	Bracket Slider Sweep Link - Sweep
000-023-182N	Nylon Slide Bar - Sweep 	090-006-129	Please refer to: 300-001-170U
000-023-216	Bumper - Sweep	090-006-130	Please refer to: 300-001-171U
000-025-004	Rod End RH 7/16 Male - Sweep, Spot & Respot	090-006-136	Shock Mount Short Stud - Sweep 
000-025-005	Rod End LH 7/16 Male - Sweep, Spot & Respot	300-000-170	Sweep Bracket Steel RH - Sweep
070-003-103	Pin Bearing - Sweep	300-001-170U	Universal Sweep Bracket RH (10 Pin) - Sweep 
070-003-106	Shaft Main Pivot - Sweep	300-000-171	Sweep Bracket Steel LH - Sweep
070-003-117	Spacer Drive Link - Sweep	300-001-171U	Universal Sweep Bracket LH (7 Pin) - Sweep 
070-003-158	Link Drive Asm - Sweep	300-000-182	Sweep Bar One Piece - Sweep
070-003-159	Tube Motor Rod - Sweep	808-557-140	Button Head Cap Screw 5/16-18 x 7/8 - Hardware
070-003-162	Connect Rod Asm - Sweep	808-557-160	Button Head Cap Screw 5/16-18 x 1 - Hardware
070-003-173	Sleeve Bearing .438 x .624 x 2 - Sweep	809-857-245	Hex Head Cap Screw 5/16-18 x1-1/2 - Hardware
070-003-184	Support Link Asm - Sweep	809-865-285	Hex Head Cap Screw 3/8-16 x 1-3/4 - Hardware
070-003-189	Pin Bearing - Sweep	809-865-445	Hex Head Cap Screw 3/8-16 x2-3/4 - Hardware
070-003-190	Bracket Shock RH-Sweep	809-869-245	Hex Head Cap Screw 7/16-14 x1-1/2 - Hardware
070-003-191	Bracket Shock LH-Sweep	809-869-325	Hex Head Cap Screw 7/16-14 x 2 - Hardware
070-003-195	Shock Mount - Sweep 	809-869-365	Hex Head Cap Screw 7/16-14 x2-1/4 - Hardware
070-003-221	Screw Sweep Link Asm - Sweep	809-869-405	Hex Head Cap Screw 7/16-14 x 2-1/2 - Hardware
070-003-222	Bracket Shock Mounting - Sweep	830-057-002	Please refer to: 844-057-002
070-003-223	Link Threaded (Popeye's Pipe) - Sweep	835-570-002	Jam Hex Nut 7/16-20 - Hardware
070-003-231	Pin Bearing - Sweep	835-574-002	Jam Hex Nut 1/2-20 - Hardware
070-003-232	Spacer Main Pivot Long - Sweep	835-582-002	Jam Hex Nut 5/8-18 - Hardware
070-003-233	Spacer Main Pivot Short- Sweep	835-670-002	Jam Hex Nut Left Hand 7/16-20 - Hardware
070-003-234	Flange Bearing .437x.75x.62 - Sweep	835-674-002	Jam Hex Nut Left Hand 1/2-20 - Hardware
070-003-235	Screw 7/16-14 - Sweep	839-057-002	P Type Nyloc Nut 5/16-18 - Hardware
070-003-238	Stabilizing Link Asm Upper - Sweep	839-665-002	Flex Lock Nut 3/8-16 - Hardware
070-003-242	Link Asm Cast - Sweep	844-057-002	P Type Nyloc Nut 5/16-18 - Hardware
070-003-243	Screw Crank Arm Drive - Sweep	844-065-002	P Type Nyloc Nut 3/8-16 - Hardware
070-006-121	Washer Clutch - Dist & Sweep	844-069-002	P Type Nyloc Nut 7/16-14 - Hardware
070-007-276	Rod Link Asm - Sweep	844-073-002	P Type Nyloc Nut 1/2-13 - Hardware
070-007-278	Tube Weldment Link - Sweep	919-005-600	External Retaining Ring #5100-62 - Hardware
070-007-280	Sweep Link Telescope Asm - Sweep	919-010-700	Retaining Ring #5133-62 - Hardware
070-007-281	Rod End Male Stubby S6179 - Sweep	948-761-112	Washer Wrought 5/16 - Hardware
070-007-282	Rod End RH 7/16 Female AF-7-G-8 - Sweep	948-767-132	Washer 13/32 - Hardware
070-007-283	Bumper Link Asm - Sweep	949-100-002	Washer 3/8 - Hardware

DB - Satisfaction Guaranteed

FRONT END DRIVE ASSEMBLIES

Pinspotter Parts for AMF Equipment



000-021-645



000-021-683



000-021-714



000-021-787



000-021-878



000-021-880



000-021-881



000-024-657



000-026-042



000-026-247



070-001-707



070-001-853



070-001-854



070-001-857



070-001-877



070-001-893



070-001-894

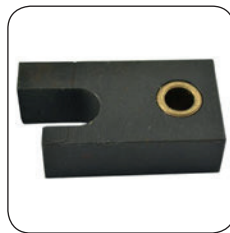

070-001-898



070-001-917



070-001-924



070-001-926



070-001-931



070-001-932

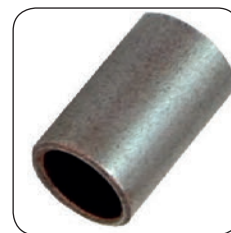

070-002-652



070-002-776

DB - Better Value Parts

FRONT END DRIVE ASSEMBLIES

Pinspotter Parts for AMF Equipment



070-002-777



070-002-778



070-002-780



070-002-824



070-006-048



070-006-310



070-006-493



070-006-729



070-007-250



070-007-303



070-007-310



070-007-311



070-007-509



070-007-510



070-007-755



070-008-321



090-005-550



190-001-490

FRONT END DRIVE ASSEMBLIES

Pinspotter Parts for AMF Equipment

000-021-645	Lever Asm Switch - Sweep & Table	070-001-931	Spring - Table Drive
000-021-683	Retainer Bearing - Drive Asm	070-001-932	Pin Actuator Asm - Table Drive
000-021-714	Screw Adjusting - Table Drive	070-002-652	Bearing Sleeve .252 x315 x.5 - Table Drive
000-021-787	Washer Thick 9/16 x 15/8 x 1/4 - Kickback	070-002-776	Bearing Cone Table Drive - Table Drive
000-021-878	Spacer Rod Asm - Table Drive	070-002-777	Cup Roller Bearing - Table Drive
000-021-880	Rod End Asm - Table Drive - With grease nipple	070-002-778	Crank Housing & Cup Asm - Table Drive
000-021-881	Ball Bearing .625 x 1.375 - Table Drive	070-002-780	Cup Roller Bearing - Table Drive
000-024-657	Spring Cam Lever - Table Drive & Sweep Cam	070-002-824	Cone Bearing & Seal Asm - Table Drive
000-026-042	Micro Switch Small Tip - Table Drive	070-006-048	Bolt Special - Dist & Table
000-026-247	Switch - Front End	070-006-310	Spacer - Front End Drive
070-001-668	Please refer to: 070-001-668SL	070-006-493	Ball Joint Asm - Spot & Respot
070-001-707	Spring - Front End Drive	070-006-729	Disc Spring - Table Drive
070-001-853	Spring - Torque Tube	070-007-250	Link Hub Asm - Table Drive
070-001-854	Screw Adjustment - Torque Tube	070-007-303	Spacer Front End - Spot & Respot
070-001-857	Nylon Roller - Dist & Table Drive	070-007-310	Flange Bearing .502 x .871 x 1.20 - Table
070-001-877	Eccentric Table Drive - Table Drive	070-007-311	Sleeve Bearing
070-001-893	Cam Ball Asm - Table Drive	070-007-509	Nut Elevating QN 1/2 - 13 - Kickback
070-001-894	Pivot Pin - Table Drive	070-007-510	Set Screw Elevating - Kickback
070-001-898	Latch Asm - Table Drive	070-007-755	Yoke Weldment
070-001-917	Compression Spring - Table Drive	070-008-321	Arm - Latch
070-001-924	Flange Bearing .753x.9395x.58 - Torque Tube	090-005-550	Table Drive Asm - Table
070-001-926	Pin - Torque Tube	190-001-490	Bearing

SPOT & RESPOT TIE ROD ASSEMBLIES

Pinspotter Parts for AMF Equipment



000-021-423



000-025-004



000-025-005



070-001-585



070-001-587



070-001-591



070-001-605

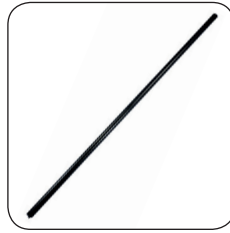

070-001-606

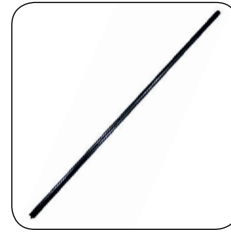

070-001-607



070-001-664



070-001-700



070-001-707



070-001-807



070-001-919



070-001-997



070-002-691



070-002-745



070-002-816



070-006-417



070-006-427



070-006-457ASM



070-006-493



070-006-496



070-007-302



070-007-303

DB - Distributed Worldwide

SPOT & RESPOT TIE ROD ASSEMBLIES

Pinspotter Parts for AMF Equipment



610-704-002



900-110-141



907-000-900



BV090005025



090-005-264



090-005-265



090-005-565



090-005-576

SPOT & RESPOT TIE ROD ASSEMBLIES

Pinspotter Parts for AMF Equipment

000-021-423	Collar & Screw 5/8 x 1 1/8 x 1/2 - Shuttle & Belt Tensioner	090-005-265	Rod End 7/16 LH - Sweep & Tie Rod
000-025-004	Rod End RH 7/16 Male - Sweep, Spot & Respot	090-005-565	Table Drive Shaft
000-025-005	Rod End LH 7/16 Male - Sweep, Spot & Respot	090-005-576	Spring Hanger New - Spot & Respot 
070-001-585	Spot Link Pin	610-704-002	Cam Follower Asm
070-001-587	Pin Spring Hanger - Spot & Respot	809-865-125	Hex Head Cap Screw 3/8-16 x 3/4 - Hardware
070-001-591	Pin Hook Spot - Torque Tube	809-865-245	Hex Head Cap Screw 3/8-16 x 1-1/2 - Hardware
070-001-602	Please refer to: 090-005-252	809-869-245	Hex Head Cap Screw 7/16-14 x 1-1/2 - Hardware
070-001-605	Upper Spotting Link Asm	809-869-285	Hex Head Cap Screw 7/16-14 x 1-3/4 - Hardware
070-001-606	Tie Rod - Spot & Respot	809-869-325	Hex Head Cap Screw 7/16-14 x 2 - Hardware
070-001-607	Tie Rod - Spot & Respot	809-869-365	Hex Head Cap Screw 7/16-14 x 2-1/4 - Hardware
070-001-664	Clamp Stud Cam - Front End Drive	809-869-405	Hex Head Cap Screw 7/16-14 x 2-1/2 - Hardware
070-001-700	Table Drive Shaft	810-265-280	Socket Head Cap Screw 3/8-16 x 1-3/4 - Hardware
070-001-707	Respot Arm Spring	835-549-002	Jam Hex Nut 1/4-20 - Hardware
070-001-751	Please refer to: 090-005-576	835-570-002	Jam Hex Nut 7/16-20 - Hardware
070-001-807	Spring Respot Finger - Table	835-670-002	Jam Hex Nut Left Hand 7/16-20 - Hardware
070-001-919	Flange Bearing .627x.814x.870 - Spot & Respot	839-665-002	Flex Lock Nut 3/8-16 - Hardware
070-001-997	Latch Asm Support Arm Asm - Spot & Respot	840-066-002	Flex Lock Thin Nut 3/8-24 - Hardware
070-002-691	Bearing .627x.752x1/2 - Spot & Respot	843-140-002	Kep Nut Washer #10-32 - Hardware
070-002-745	Flange Bearing .6265x.814x1/2 - Table	844-065-002	P Type Nyloc Nut 3/8-16 - Hardware
070-002-816	Cam Follower - Table	844-069-002	P Type Nyloc Nut 7/16-14 - Hardware
070-006-407	Please refer to: 070-006-427	844-070-002	P Type Nyloc Nut 7/16-20 - Hardware
070-006-417	Table Cam Weld - Front End Drive	844-073-002	P Type Nyloc Nut 1/2-13 - Hardware
070-006-427	Cam Shuttle - Table Drive	900-110-141	Sleeve Bearing .628 x.878 x7/8 - Kicker
070-006-457ASM	Shaft Table - Spot & Respot	907-000-900	Key #910 HyPro - Front End Drive, LBS & Kicker
070-006-493	Ball Joint Asm - Spot & Respot	913-423-120	Spring Pin .125 x 3/4 - Hardware
070-006-496	Screw Hex 3/8-16 x 7 - Spot & Respot	913-464-360	Spring Pin .375 x 2 1/4 - Hardware
070-007-302	Spacer Front End-Torque Tube	948-767-132	Washer 3/8 - Hardware
070-007-303	Spacer Front End - Spot & Respot	948-983-212	Washer 5/8 - Hardware
090-005-025	Shaft Hardened Spot Respot- Front End	949-100-002	Washer 3/8 - Hardware
090-005-264	Rod End 7/16 RH - Sweep & Tie Rod	951-164-002	Spring Lock Washer 3/8 - Hardware

BIN ASSEMBLY



AV 000-021-992
Blue Urethane Grommet
• Soft, non-stick & hard wearing



AV 070-006-353
Guide Pin
• Easy clean galvanised steel



AV 070-006-354
Shock Mount
• Submerged integral fixing



AV 070-006-363
Pin Pusher Brackets
• Reduces double shuttling on the back row



AV 070-006-364
Spacer But Pin Guide
• Easy clean galvanised steel



AV 070-006-380
Pin Guide Ear RH #4
• Easy clean galvanised steel



AV 070-006-381
Pin Guide Ear LH #6
• Easy clean galvanised steel



AV 070-006-386
Track Asm LH
• Fitted with replaceable rollers



AV 070-006-388
Track Asm RH
• Fitted with replaceable rollers

BIN ASSEMBLY

Pinspotter Parts for AMF Equipment



000-022-168



000-026-043



000-026-251



000-026-446



000-029-614



070-006-142



070-006-351



070-006-356



070-006-359



070-006-372



070-006-373



070-006-376



070-006-377



070-006-384



070-006-389



070-006-390



070-006-402



070-006-403

BIN ASSEMBLY

Pinspotter Parts for AMF Equipment

000-021-992	Blue Urethane Grommet - Bin & Pin Elevator 	070-006-390	Spacer- Bin
000-022-168	Spring Sweep Brake - Bin	070-006-402	Shaft - Bin
000-026-043	Micro Switch Big Tip - Bin	070-006-403	Stud Clamp - Bin
000-026-251	Roller Screw & Star Washer - Dist & Bin 	808-549-080	Button Head Cap Screw 1/4-20 x 1/2 - Hardware
000-026-446	Rod End RH 3/8 Female - Bin & Track Rail	809-849-085	Hex Head Cap Screw 1/4-20 x 1/2 - Hardware
000-029-614	Unibal Bearing 3/8 ID x 1.00 OD - Bin 	809-849-125	Hex Head Cap Screw 1/4-20 x 3/4 - Hardware
070-006-142	Bumper - Multi Position	809-849-165	Hex Head Cap Screw 1/4-20 x 1 - Hardware
070-006-351	Rod Asm - Bin	809-849-285	Hex Head Cap Screw 1/4-20 x 1-3/4 - Hardware
070-006-353	Guide Pin - Bin 	809-849-605	Hex Head Cap Screw 1/4-20 x 3-3/4 - Hardware
070-006-354	Shock Mount - Bin 	809-865-165	Hex Head Cap Screw 3/8-16 x 1 - Hardware
070-006-356	Switch Actuator 9 Pin - Bin	813-540-082	Pan Head Screw #10-32 x 1/2 CD - Hardware
070-006-359	Bracket - Bin	831-565-002	Hex Nut 3/8-16 - Hardware
070-006-363	Please refer to: 022-610-005 	835-566-002	Jam Hex Nut 3/8-24 - Hardware
070-006-364	Spacer But Pin Guide - Bin 	840-049-002	Flex Lock Thin Nut 1/4-20 - Hardware
070-006-372	Stringer Centre RH + LH	843-127-002	Kep Nut Washer #6-32 - Hardware
070-006-373	Stringer Centre LH + RH	843-133-002	Please refer to: 839-533-002
070-006-376	Stringer Outside RH (10 Pin)	844-049-002	P Type Nyloc Nut 1/4-20 - Hardware
070-006-377	Stringer Outside LH (7 Pin)	844-065-002	P Type Nyloc Nut 3/8-16 - Hardware
070-006-380	Pin Guide Ear RH #4 - Bin 	900-114-101	Sleeve Bearing .877 x 1.128 x 5/8 - Bin
070-006-381	Pin Guide Ear LH #6 - Bin 	900-206-091	Flange Bearing .378 x .503 x 9/16 - Dist
070-006-384	Bracket Weld # 5 Pin Only - Bin	907-000-600	Key #706 HyPro - Yoke & Spotting Cup & Bin
070-006-386	Track Asm LH - Bin 	948-631-062	Washer 3/16 - Hardware
070-006-388	Track Asm RH - Bin 	948-753-102	Washer 1/4 - Hardware
070-006-389	Guide Pin #1- Bin	957-000-002	Lock Washer #6 External Tooth - Hardware

DB - Satisfaction Guaranteed

SHUTTLE & SOLENOID ASSEMBLY



AV 022-610-002
Rear Shuttle Mount Kit
• Adjustable, positive slide action

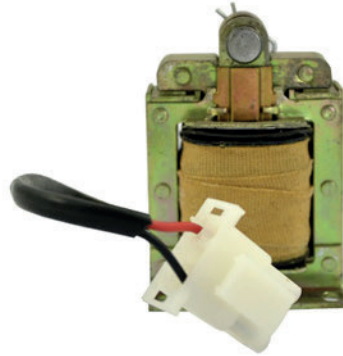

AV 070-006-727
Spotting Solenoid
• Single 240v voltage with shaft and connectors



AV 088-001-631
Shuttle Rod Asm
• New style with giant spring



AV 070-006-306GSK
Giant Spring Conversion Kit
• Convert your existing shuttle rod Asm



AV 070-006-001
Solenoid Link Asm
• Laser cut stainless steel components

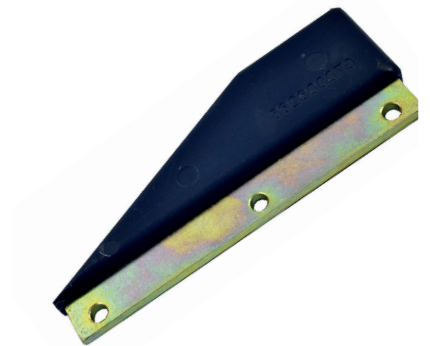

AV 070-006-265
Pin Holder Slick Blue
• Durable smooth blue hard plastic



AV 070-006-268SR
Ultra Bin Strap, Zinc Plated
• Easy fit, pre threaded fixings



AV 070-006-259
Adjustable Shuttle Bracket
• Lock slotted fixing



AV 090-005-723UPG
Ultra Spotting Solenoid - Shuttle
• Revised mount position, simplified operation for 70's & 90's

SHUTTLE & SOLENOID ASSEMBLY

Pinspotter Parts for AMF Equipment



000-021-423



000-021-442



000-021-645



000-021-683



000-023-139



000-024-657



000-026-042



070-001-664



070-001-699



070-001-774



070-001-777



070-002-653



070-006-046



070-006-116



070-006-142



070-006-253



070-006-254

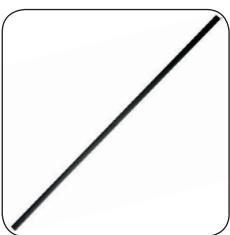

070-006-255

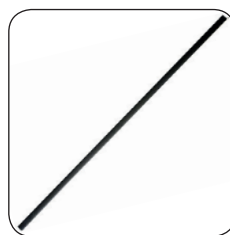

070-006-256



070-006-257



070-006-258



070-006-260



070-006-261

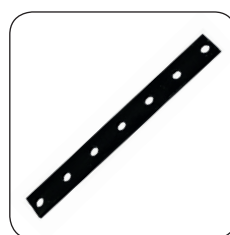

070-006-266



070-006-268

DB - Designed by Technicians for Technicians

SHUTTLE & SOLENOID ASSEMBLY

Pinspotter Parts for AMF Equipment



070-006-276



070-006-277



070-006-278

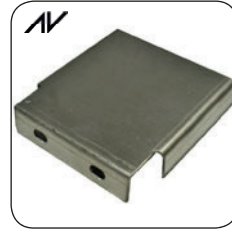

070-006-279



070-006-280



070-006-282



070-006-283



070-006-284



070-006-285



070-006-286



070-006-287



070-006-289



070-006-295



070-006-296



070-006-302



070-006-304



070-006-306



070-006-307



070-006-447



070-006-449



070-006-450



070-006-484



070-006-724

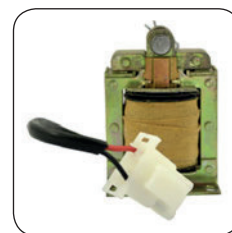

070-006-726



070-008-133

DB - Developed in the United Kingdom

SHUTTLE & SOLENOID ASSEMBLY

Pinspotter Parts for AMF Equipment



070-008-135



088-500-157



090-005-018



090-005-028



090-005-263



610-704-002



610-704-015



701-416-058

SHUTTLE & SOLENOID ASSEMBLY

Pinspotter Parts for AMF Equipment

000-021-423	Collar & Screw 5/8 x 1 1/8 x 1/2 - Shuttle & Belt Tensioner	070-006-302	Plug Shuttle Op Rod- Shuttle & Solenoid
000-021-442	Rubber Washer - Shuttle & Solenoid	070-006-304	Rod Asm - Shuttle
000-021-645	Lever Asm Switch - Sweep & Table	070-006-306	Spring - Shuttle
000-021-683	Retainer Bearing - Drive Asm	070-006-306GSK	Giant Spring Conversion Kit 
000-023-139	Arm Crank - Front End Drive	070-006-307	Link Asm - Shuttle
000-024-657	Spring Cam Lever - Table Drive & Sweep Cam	070-006-447	Spring - Shuttle
000-026-042	Micro Switch Small Tip - Table Drive	070-006-449	Cam Weld SB & SC Sweep-Front End Drive
022-610-002	Rear Shuttle Mount Kit 	070-006-450	Cam weld SA Sweep- Front End Drive
070-001-664	Clamp Stud Cam - Front End Drive	070-006-484	Lever Asm Stop - Shuttle
070-001-699	Sweep Drive Shaft - Front End Drive	070-006-724	Solenoid Small Stainless Link - Spotting Solenoid 
070-001-774	Link Asm - Shuttle & Solenoid	070-006-726	Spot Solenoid 60Hz 115V - Spotting Solenoid 
070-001-777	Pin - Shuttle & Solenoid	070-006-727	Spotting Solenoid - Solenoid & Shuttle
070-002-653	Flange Bearing .252 x.315 x.38 - Table drive	070-008-133	Spacer Link - Shuttle & Solenoid
070-006-001	Solenoid Link ASM- Shuttle 	070-008-135	Link Asm- Shuttle & Solenoid
070-006-046	Rod End Support - Pin Elevator & Shuttle	088-001-631	Shuttle Rod With Large Spring ASM - Shuttle 
070-006-116	Stud Clamp Carriage - Dist & Shuttle	088-500-157	Tube Shuttle Center - Shuttle
070-006-142	Bumper - Multi Position	090-005-018	Solenoid Bracket - Spotting Solenoid
070-006-253	Tube Cross Long- Shuttle	090-005-028	Solenoid Pivot - Spotting Solenoid
070-006-254	Tube Side Short - Shuttle	090-005-263	Shuttle Rod ASM
070-006-255	Tube Side Long - Shuttle	090-005-723UG	Ultra Spotting Solenoid - Shuttle 
070-006-256	Tube Outside - Shuttle	090-005-723	Solenoid Asm 115/230v 50/60Hz - Spotting Solenoid
070-006-257	Tube Center - Shuttle	610-704-002	Cam Follower Asm - Shuttle & Spot
070-006-258	Tube Cross Short- Shuttle	610-704-015	Kit Link Replacement Asm - Shuttle & Solenoid
070-006-259	Bracket Arm - Shuttle 	701-416-058	Flange Bearing .502 x.627 x 1.0 - Shuttle & Solenoid
070-006-260	Bumper Counter Bin -Shuttle	809-849-245	Hex Head Cap Screw 1/4-20 x 1-1/2 - Hardware
070-006-261	Clamp End - Shuttle	809-849-285	Hex Head Cap Screw 1/4-20 x 1-3/4 - Hardware
070-006-265	Pin Holder Slick - Bin 	809-865-205	Hex Head Cap Screw 3/8-16 x 1-1/4 - Hardware
070-006-266	Strap 7 Hole Spring - Shuttle	809-873-405	Hex Head Cap Screw 1/2-13 x 2-1/2 - Hardware
070-006-268	Bin Strap Extra Wide - Bin 	813-933-162	Machine Hex Head Screw #8-32 x 1 CD - Hardware
070-006-268SR	Bin Strap Reinforced - Shuttle 	814-333-122	Machine Hex Head Screw #8-32 x 3/4 - Hardware
070-006-276	Spring Drive - Shuttle	835-549-002	Jam Hex Nut 1/4-20 - Hardware
070-006-277	Washer Spring - Shuttle 	835-566-002	Jam Hex Nut 3/8-24 - Hardware
070-006-278	Lever Cam- Shuttle and Solenoid	840-065-002	Flex Lock Thin Nut 3/8-16 - Hardware
070-006-279	Solenoid Guard- Shuttle & Solenoid 	844-049-002	P Type Nyloc Nut 1/4-20 - Hardware
070-006-280	Clip Spring Shuttle-Drive Shuttle & Solenoid	844-073-002	P Type Nyloc Nut 1/2-13 - Hardware
070-006-282	Solenoid Link Stainless - Spotting Solenoid 	900-204-121	Flange Bearing .25 x.378 x3/4 - Shuttle & Solenoid
070-006-283	Spring - Spotting Solenoid	900-210-161	Flange Bearing .628 x 1 BZ - PBL, Shuttle & Solenoid
070-006-284	Stud Clamp - Shuttle	907-000-200	Key #404 HyPro - Shuttle & Ratchet
070-006-285	Shaft-Shuttle & Solenoid	907-000-900	Key #910 HyPro - Front End Drive, LBS & Kicker
070-006-286	Shaft Cam Lever - Shuttle	913-415-100	Spring Pin .094 x 5/8 - Hardware
070-006-287	Pin Long Shuttle & Solenoid	913-415-120	Spring Pin .094 x 3/4 - Hardware
070-006-289	Shaft- Shuttle & Solenoid	913-464-400	Spring Pin .375 x 2 1/2 - Hardware
070-006-295	Lever Shuttle Op Rod- Shuttle & Solenoid	963-200-002	X - Washer 1/8 9000-8 - Hardware
070-006-296	Spring Cap - Spotting Solenoid		

TABLE ASSEMBLY

Pinspotter Parts for AMF Equipment



000-021-645



000-022-737



000-022-738



000-024-657



000-026-042



070-001-591



070-001-804



070-001-807



070-001-853



070-001-854



070-001-871



070-001-924



070-001-926



070-002-577



070-002-579

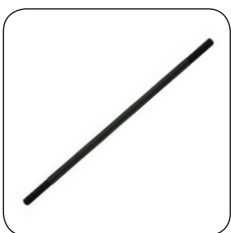

070-002-581



070-002-583



070-002-584



070-002-585



070-002-590



070-002-592



070-002-594



070-002-596



070-002-630



070-002-652

DB - Developed in the United Kingdom

TABLE ASSEMBLY

Pinspotter Parts for AMF Equipment



070-002-653



070-002-667

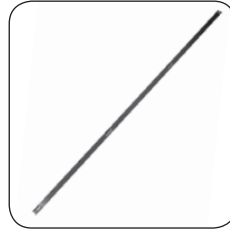

070-002-671



070-002-680



070-002-681



070-002-702



070-002-715



070-002-726



070-002-728



070-002-732



070-002-733



070-002-734



070-002-745



070-002-815



070-002-816



070-006-639



070-007-303



070-007-616



070-007-622



070-007-623



090-002-028



090-005-264



090-005-265



090-005-503



090-005-504

DB - Distributed Worldwide

TABLE ASSEMBLY

Pinspotter Parts for AMF Equipment



090-005-550



090-005-553



090-005-571



090-005-600



090-005-612



730-027-019



879-849-487



900-114-101



900-205-081



963-400-002

TABLE ASSEMBLY

Pinspotter Parts for AMF Equipment

000-021-645	Lever Asm Switch - Sweep & Table	070-002-745	Flange Bearing .6265 x .814 x 1/2 - Table
000-022-737	Rod End LH 1/4-28 UNF - Table	070-002-815	Bearing Spacer
000-022-738	Rod End RH 1/4-28 UNF - Table	070-002-816	Cam Follower - Table
000-024-657	Spring Cam Lever - Table Drive & Sweep Cam	070-006-639	C Washer - Kickback
000-026-042	Micro Switch	070-007-303	Spacer, Front End
070-001-591	Pin	070-007-616	Pivot Pin 5/16 Respot Lever - Table
070-001-804	Pivot Weldment Respot - Table	070-007-622	Lever Respot Asm- Table
070-001-807	Spring Respot Finger - Table	070-007-623	Lever, Respot Asm
070-001-853	Spring	090-002-028	Pin, Spring Roller
070-001-854	Screw Adjustment - Torque Tube	090-005-264	End Fitting - RH
070-001-871	Hex Head Screw Cam Link - Table	090-005-265	End Fitting - LH
070-001-924	Flange Bearing .753x.9395x.58 - Torque Tube	090-005-503	Link Connector
070-001-926	Pin - Torque Tube	090-005-504	Respot Pivot
070-002-577	Stud Spring Yoke Asm - Table	090-005-550	Table Drive Asm
070-002-579	Lever Asm Finger - Table	090-005-553	Shaft No 1
070-002-581	Tie Rod - Table	090-005-571	Link, Pins 8, 9, 10
070-002-583	Link Asm Actuating - Table	090-005-600	Artuator Lever Weldment
070-002-584	Pin Bell Crank - Table	090-005-612	Pin, Front Connecting Link
070-002-585	Shaft Lever Asm - Table	730-027-019	Stud, Ball Head
070-002-590	Finger Link - Table	807-357-060	Grub Screw 5/16-18 x 3/8 - Hardware
070-002-592	Pin Finger -Table	809-865-245	Hex Head Cap Screw
070-002-594	Tie Rod Asm -Table	809-869-325	Hex Head Cap Screw
070-002-596	Spring Yoke Asm - Table	835-549-002	Nut, Hex Jam 1/4-20
070-002-630	Flange Bearing .252 x .315 x .218	835-570-002	Nut Hex Jam
070-002-652	Bearing Sleeve .252 x .315 x .5 - Table Drive	835-670-002	Nut Hex Jam
070-002-653	Flange Bearing .252 x .315 x .38 - Table drive	838-369-002	Lock Nut
070-002-667	Leg Only - Table	839-665-002	Nut Flex Lock
070-002-671	Link, Respot Connecting	843-127-002	Nut Keps
070-002-680	Lever Respot Asm - Table	844-049-002	P-Nut 1/4-20
070-002-681	Pivot Pin 1/4" Respot Lever - Table	879-849-487	Eyebolt
070-002-701	Pin Yoke Legs - Yoke & Spotting Cup	900-114-101	Sleeve Bearing
070-002-702	Stop - Table	900-205-081	Flange Bearing .315 x 44 x 500"
070-002-715	Bearing Sleeve .502 x.689 x1.5 - Table	945-867-242	Washer 10m
070-002-726	Shaft - Table	948-753-102	Washer, 9/32 x 5/8 x 1/16
070-002-728	Cam Link Bearing Asm - Table	948-983-212	Washer
070-002-732	Spring - Table	949-100-002	Washer
070-002-733	Screw Cam Link - Table	963-400-002	X Washer
070-002-734	Bracket Spring Cam Link - Table		

DB - Satisfaction Guaranteed

YOKE & BEARING ASSEMBLY

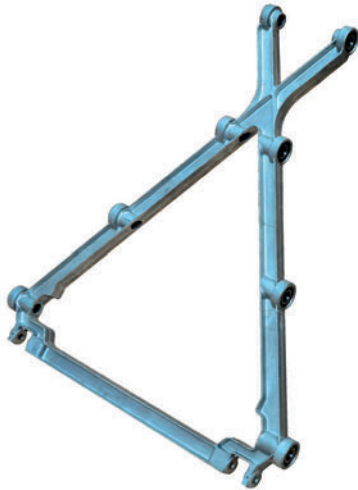

AV 070-002-623
Yoke & Bearing Asm
• True cast with punched bearings



AV 070-002-787XL
U-Bolt Extra Long Giant Spring Conversion Kit
• For increased adjustment



AV 070-002-784
Spotting cup Liner
• Soft, non-stick & hard wearing



AV 610-704-011
Yoke Repair Kit
• Your get out of jail free card



AV 070-002-809P
Premium HP Spotting Cup
• Heavy weight casting



AV 070-002-809
Lightweight Spotting Cup - Standard
• Standard light weight casting

AV - Add value to your equipment

YOKE & BEARING ASSEMBLY

Pinspotter Parts for AMF Equipment



000-023-114



000-025-549



070-002-602



070-002-603



070-002-608



070-002-609



070-002-612



070-002-615



070-002-616



070-002-617



070-002-618



070-002-624



070-002-664



070-002-665

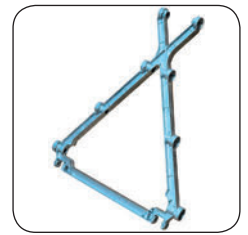

070-002-683



070-002-688



070-002-689



070-002-698



070-002-719



070-002-723



070-002-787



070-002-788



070-002-808



190-002-808



710-310-0365L

DB - Developed in the United Kingdom

YOKE & BEARING ASSEMBLY

Pinspotter Parts for AMF Equipment

000-023-114	Flange Bearing .628 x .8155 x.06 - Sweep, Yoke & Spotting Cup	070-002-784	Spotting Cup Liner Blue - Spotting Cup 
000-025-549	Collar 7/8 x 1 1/2 x 9/16 - Yoke & Spotting Cup	070-002-787XL	U-Bolt Extra Long - Spotting Cup 
070-002-602	Lever Inner Yoke - Spotting Cup	070-002-788	Cap Clamp - Spotting Cup
070-002-603	Lever Outer Yoke - Spotting Cup	070-002-808	Spotting Cup Asm With Cap & Hardware
070-002-608	Collar Spring - Yoke & Spotting Cup	070-002-809P	Premium HP Spotting Cup 
070-002-609	Pin Lever Rear Yoke Asm - Spotting Cup	070-002-809	Lightweight Spotting Cup - Standard 
070-002-612	Tie Link Asm - Yoke & Spotting Cup	070-002-818	Please refer to: 000-021-442
070-002-615	Shaft #1 - Yoke & Spotting Cup	610-704-011	Yoke Repair Kit - Yoke & Bearing Asm 
070-002-616	Shaft #2 - Yoke & Spotting Cup	701-310-036SL	Anti-Loss Nylon Thrust Bearing
070-002-617	Shaft #3 - Yoke & Spotting Cup	809-865-245	Hex Head Cap Screw 3/8-16 x 1-1/2 - Hardware
070-002-618	Shaft #4 - Yoke & Spotting Cup	810-249-200	Socket Head Cap Screw 1/4-20 x 1-1/4 - Hardware
070-002-623	Yoke & Bearing Asm 	810-258-160	Socket Head Cap Screw 5/16-24 x 1 - Hardware
070-002-624	Arm Actuator - Yoke & Spotting Cup	835-565-002	Jam Hex Nut 3/8-16 - Hardware
070-002-664	Leg Asm Front LH - Yoke & Spotting Cup	839-057-002	Please refer to: 844-057-002
070-002-665	Leg Asm Rear - Table & Yoke	839-565-002	Flex Lock Nut 3/8-16 - Hardware
070-002-683	Yoke Without Bearings	844-049-002	P Type Nyloc Nut 1/4-20 - Hardware
070-002-688	Spring RH - Yoke & Spotting Cup	900-205-053	Flange Bearing .315 x.44 x5/16 - Yoke & Spotting Cup & Wireway
070-002-689	Spring LH - Yoke & Spotting Cup	900-205-053SL	Self- Lube Flange Bearing - Yoke & Bearing
070-002-698	Bearing SR .625 x1.562 x7/8 S6586 - Table Torque & Yoke	919-000-700	Internal Retaining Ring #5000-156 - Hardware
070-002-719	Sleeve Spring Yoke - Yoke & Spotting Cup	948-761-112	Washer Wrought 5/16 - Hardware
070-002-723	Pin Actuator Shaft - Yoke & Spotting Cup		

DB - Distributed Worldwide

TABLE TORQUE TUBE ASSEMBLY



610-704-103
Spring Roller Repair Kit
• Be prepared if your stud breaks



612-070-012
Counter Balance Spring Table Fix Kit
• If your hook breaks off the table



090-005-015
Torque Tube Bearing
• New smaller hole less slack

Pinspotter Parts for AMF Equipment



000-022-782



070-001-668SL



070-001-853



070-002-698



000-022-811



000-022-811T



070-007-303

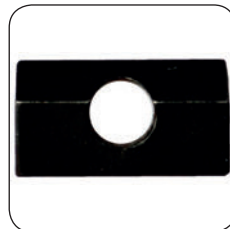

070-008-182



090-004-007







090-005-662

Pinspotter Parts for AMF Equipment

000-022-782	Spring Counter Balance	070-007-303	Spacer Front End - Spot & Respot
000-022-811	Pillow Block	070-008-182	Block Bearing - Torque Tube
000-022-811T	Dura Pillow Block	090-004-007	Torque Tube Hanger
070-001-668SL	Self-Lube Spring Roller - Table	090-005-015	Torque Tube Bearing
070-001-853	Spring - Torque Tube	090-005-662	Counter Balance Spring
070-002-698	Bearing SR.625 x1.562 x7/8 S6586 - Table Torque & Yoke	610-704-103	Kit-Spring Roller Pin Repair Kit - Table
070-007-302	Spacer Front End-Torque Tube	612-070-012	Counter Balance Spring Eye Repair Kit - Table

TABLE WIREWAY ASSEMBLY



-  070-006-669 Steel Table Link 1, 2, 4, 7 - Wireway
-  070-002-768 Steel Table Link 3, 5, 8 - Wireway
-  070-002-769 Steel Table Link 6, 9 - Wireway
-  070-002-770 Steel Table Link 10 - Wireway

- Replaces old fashioned wire ways

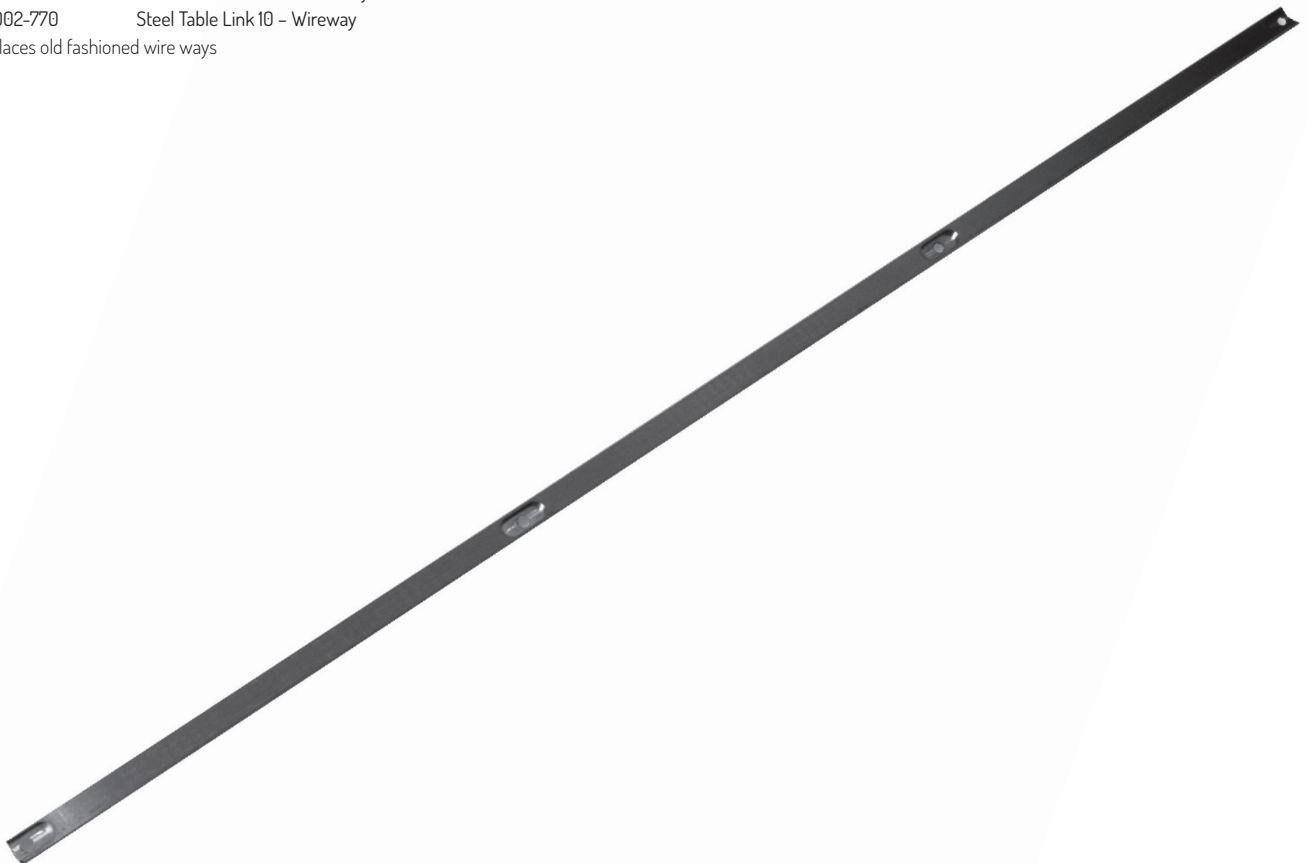

-  070-002-671 Solid Link Respot Connector
- Solid Stainless replaces fabricated tin

TABLE WIREWAY ASSEMBLY

Pinspotter Parts for AMF Equipment



000-026-865



070-002-582



070-002-652



070-002-653



070-002-678



070-002-758



070-002-772



070-002-773

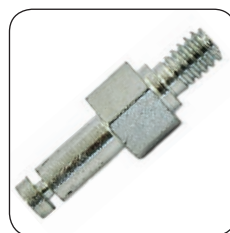

070-002-774



070-002-814



070-002-815



070-007-623



730-027-019





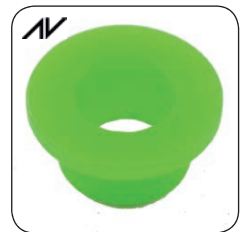

900-205-053



900-205-053SL

Pinspotter Parts for AMF Equipment

000-026-865	Thrust washer 1/4 x 7/8 - Dist & Ratchet	070-002-773	Grommet Table Asm - Wireway
070-002-582	Drive Link Asm Rear - Wireway	070-002-774	Pin - Wireway
070-002-652	Bearing Sleeve .252 x.315 x.5 - Table Drive	070-002-814	Link Asm - Wireway
070-002-653	Flange Bearing .252 x.315 x.38 - Table drive	070-002-815	Bearing .252x.318x.307 LG - Wireway
070-002-671	Solid Link Respot Connector - Table 	070-006-669	Link Steel - Wireway 
070-002-678	Lever Respot Asm - Wireway	070-007-623	Lever Respot Asm - Wireway
070-002-758	Lever & Bushing Asm - Switch Table	730-027-019	Stud Ball Head 1/4 - 20 - Wireway
070-002-768	Link Table Steel - Wireway 	844-049-002	P Type Nyloc Nut 1/4-20 - Hardware
070-002-769	Link Table Steel - Wireway 	900-205-053	Flange Bearing .315 x.44 x5/16 - Yoke & Spotting Cup & Wireway
070-002-770	Link Table Steel - Wireway 	900-205-053SL	Self- Lube Flange Bearing 
070-002-772	Pin Plate Table - Wireway	963-200-002	X - Washer 1/8 9000-8 - Hardware

DB - Satisfaction Guaranteed

RESPOT CELL ASSEMBLY

8270 / Early 8290



070-002-570



070-002-629



070-002-630



070-002-632



070-002-633



070-002-644



070-002-645



070-002-646



070-002-649



070-002-650



070-002-652



070-002-653



070-002-654



070-002-685



070-002-750



070-002-752



070-002-774



070-002-792



070-006-519



070-007-192



070-007-193



070-007-194



070-007-195



070-007-196



070-007-197

DB - Better Value Parts

RESPOT CELL ASSEMBLY

8270 / Early 8290



070-007-1970



070-007-200



070-007-261



070-007-617



070-007-618M



070-007-619



070-007-620



070-008-154



090-004-123

8270 / Early 8290

070-002-570	Insert Yoke Arm - Respot Cell	070-007-193	Nylon Spacer - Respot Cell
070-002-629	Yoke Respot Asm - Respot Cell	070-007-194	Stud Long - Respot Cell
070-002-630	Flange Bearing .252 x.315 x.218 - Respot Cell	070-007-195	Stud Short - Respot Cell
070-002-632	Adjusting Screw - Respot Cell	070-007-196	Flange Bearing .252x.485x.560 - Respot Cell
070-002-633	Lever Respot Asm - Respot Cell	070-007-197	Plastic Insert Round Hole - Respot Cell
070-002-644	Plate Yoke Asm - Respot Cell	070-007-1970	Original Insert Round Hole - Respot Cell
070-002-645	Shaft Lever Asm - Respot Cell	070-007-199	Respot Cell Asm #7 - Respot Cell
070-002-646	Arm Respot Yoke Asm - Respot Cell	070-007-200	Respot Cell Asm - Respot Cell
070-002-649	Spring Tension - Respot Cell	070-007-261	Finger With Round Hole - Respot Cell
070-002-650	Stud - Respot	070-007-617	Pivot Stud 5/16 - Respot Cell
070-002-652	Bearing Sleeve .252 x.315 x.5 - Table Drive	070-007-618	Please refer to: 070007618M
070-002-653	Flange Bearing .252 x.315 x.38 - Table drive	070-007-618M	Lever Respot Asm Modified - Respot Cell
070-002-654	Pivot Shaft 1/4 - Respot Cell	070-007-619	Respot Yoke Asm - Respot Cell
070-002-685	Shaft Pivot #7 - Respot Cell	070-007-620	Lever Asm #7 Cell - Respot Cell
070-002-750	Screw Flat Head - Respot Cell	070-008-154	Pivot Pin #7 Cell- Respot Cell
070-002-752	Bumper Pillow Extension - Respot Cell	090-004-123	Respot Finger Asm - Respot Cell
070-002-774	Pin	808-640-121	Cap Head Patched #10-32 x 3/4 - Hardware
070-002-792	Frame Respot Weld - Respot Cell	808-640-141	Cap Head Patched #10-32 x 7/8 - Hardware
070-006-519	Respot Gauge - Tool	844-049-002	P Type Nyloc Nut 1/4-20 - Hardware
070-006-673	Please refer to: 070-007-618	913-437-100	Spring Pin .187 x 5/8 - Hardware
070-006-674	Please refer to: 070-007-200	963-100-002	X - Washer 3/32 9000-6 - Hardware
070-007-192	Washer - Respot Cell & PBL	963-200-002	X - Washer 1/8 9000-8 - Hardware
		963-400-002	X - Washer 3/16 9000-12 - Hardware

DB - Designed by Technicians for Technicians

RESPOT CELL ASSEMBLY

8290



070-002-630



070-002-645



070-002-651



070-002-653



070-002-653SL



070-002-695



070-002-750



070-007-192



070-007-193



070-007-195



070-007-618M



090-004-113



090-004-118



090-004-119



090-004-123



090-005-504



090-005-522



090-005-571



090-005-617



090-005-632



090-005-640



730-027-019



792-506-033

DB - Developed in the United Kingdom

RESPOT CELL ASSEMBLY

8290

070-002-630	Flange Bearing .252 x.315 x.218 - Respot Cell	090-004-123	Respot Finger Asm - Respot Cell 
070-002-645	Shaft Lever Asm - Respot Cell	090-005-504	Respot Pivot - Respot Cell
070-002-651	Refer to: 070-007-618	090-005-522	Bushing Respot Finger - Respot Cell
070-002-653	Flange Bearing .252 x.315 x.38 - Table drive	090-005-571	Pin 8-9-10 Link Kit 
070-002-653SL	Self-Lube Bearing - Respot Cell	090-005-617	Ski Finger Insert - Respot Cell 
070-002-695	Plate Only - Respot Cell	090-005-632	Finger Pivot Wing - Respot Cell
070-002-750	Screw Flat Head - Respot Cell	090-005-640	Stud Long - Respot Cell
070-007-192	Washer - Respot Cell & PBL	730-027-019	Stud Ball Head 1/4 - 20 - Wireway
070-007-193	Nylon Spacer - Respot Cell	792-506-033	Finger Insert Square Hole - Respot Cell
070-007-195	Stud Short - Respot Cell	807-650-050	Grub Screw 1/4-28 x 5/16 Set Screw - Hardware
070-007-618M	Lever Respot Asm Modified - Respot Cell	808-549-080	Button Head Cap Screw 1/4-20 x 1/2 - Hardware
090-004-113	Arm Respot Yoke With Shaft - Respot Cell 	809-149-100	Hex Head Cap Screw 1/4-20 x 5/8 With Patch - Hardware
090-004-118	Respot Yoke - Respot Cell	844-049-002	P Type Nyloc Nut 1/4-20 - Hardware
090-004-119	Finger With Square Hole - Respot Cell 	963-200-002	X - Washer 1/8 9000-8 - Hardware

DISTRIBUTOR ASSEMBLY



AV 070-006-757RH
Distributor Belt Red Hot
• Thick but pliable high grip with lacing



AV 070-006-757T
Distributor Belt Track
• High profile for constant pin positioning with lacing



AV 070-006-757GT
Distributor Belt Grip-Trac
• Liquorice like poly V parallel lined



AV 070-004-757W
Distributor Belt Waffle
• The American favourite



AV 070-006-034
Super Spring Linear
• 50% stronger than the original!



AV 070-006-042
Distributor Runner Belt Reart
• Adjustable Belt Runner

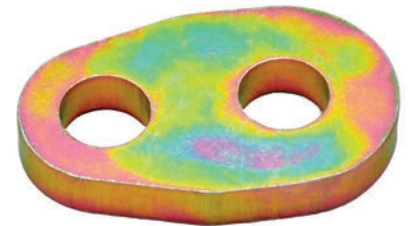

AV 070-006-068
Support Spring-Dist
• Extra thick material



AV 070-006-103
Support Guide LH - Dist
• Extra material at stress point



AV 070-006-118
Eccentric Bearing Grooved
• Distinctive blue non wobble moulded bearing



AV 070-011-910
Orientor Pan Wipe
• Improved material increased life

DISTRIBUTOR ASSEMBLY

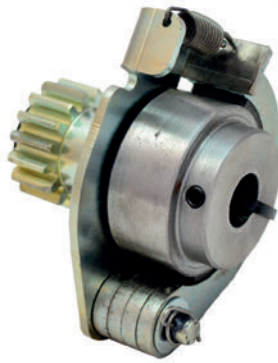

AV 610-704-006D
Duraclutch Asm

- The original brake clutch
- Positive drive action
- Developed in the UK



610-704-004



610-704-007



610-704-008



610-704-009

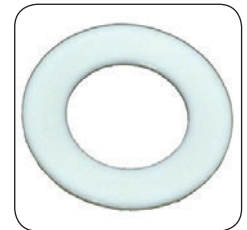

610-704-013



610-704-016



610-704-017



610-704-020



610-704-115

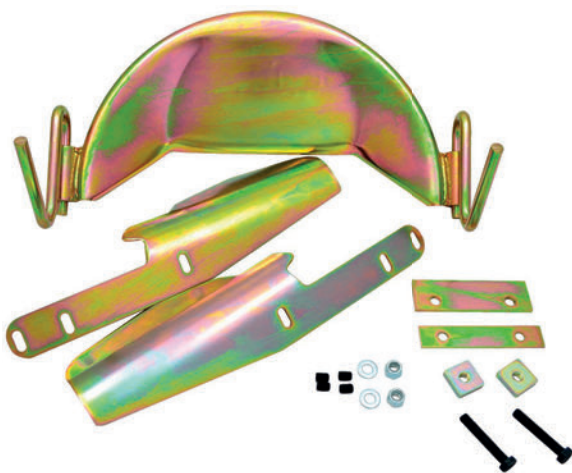

AV 022-610-004
Fixed Orienter Pan Kit - One Pinspotter

- Total control of pin orientation



022-090-018
Fixed Orienter Pan 8290 Adapter Kit

DISTRIBUTOR ASSEMBLY

Pinspotter Parts for AMF Equipment



000-006-001



000-022-173



000-024-679



000-026-031



000-026-081



000-026-251



000-026-865



000-028-267



070-001-857



070-006-004



070-006-011

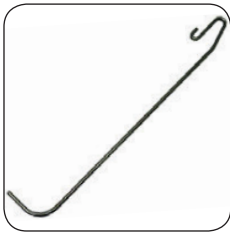

070-006-013



070-006-014



070-006-015



070-006-016



070-006-019



070-006-021



070-006-022



070-006-028



070-006-029



070-006-0340



070-006-035

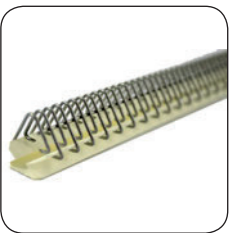

070-006-036



070-006-037



070-006-049

DB - Satisfaction Guaranteed

DISTRIBUTOR ASSEMBLY

Pinspotter Parts for AMF Equipment



070-006-051



070-006-055



070-006-061



070-006-066



070-006-067



070-006-069



070-006-071



070-006-073



070-006-075



070-006-076



070-006-077



070-006-082



070-006-084



070-006-087



070-006-104



070-006-105



070-006-106



070-006-107



070-006-108



070-006-109



070-006-111



070-006-116



070-006-117



070-006-121



070-006-124

DB - Better Value Parts

DISTRIBUTOR ASSEMBLY

Pinspotter Parts for AMF Equipment



070-006-125



070-006-126

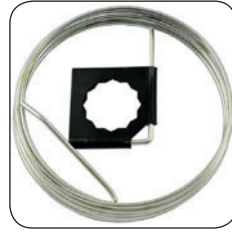

070-006-128



070-006-130



070-006-137



070-006-139



070-006-140



070-006-142



070-006-144



070-006-149

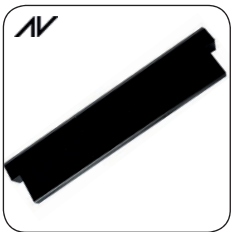

070-006-201



070-006-659



070-006-661



070-006-666



070-006-667



070-006-676



070-006-679



070-006-683

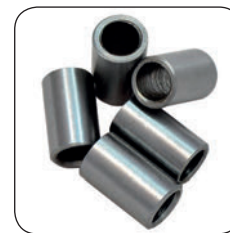

070-006-685



070-006-691



070-007-376



070-007-586



070-007-651



070-008-004



070-009-868

DB - Designed by Technicians for Technicians

DISTRIBUTOR ASSEMBLY

Pinspotter Parts for AMF Equipment



070-011-170



070-011-171



070-011-172



070-011-173



610-704-005

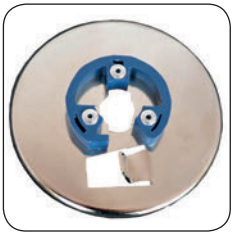

610-704-006



612-700-001



701-710-098



701-712-097



701-849-124

DISTRIBUTOR ASSEMBLY

Pinspotter Parts for AMF Equipment

000-006-001	Index cam follower kit - Dist 	070-006-076	Needle Bearing 1" Open End - Dist
000-022-173	Nut Special Roller - Dist & Kicker	070-006-077	Drive Shaft - Dist
000-024-679	Ball bearing .625 x 1.375 - Dist & Kicker	070-006-082	Pin Spring Post- Dist
000-026-031	Belt Tightner Spring - Dist & LBS	070-006-084	Bracket Trip Stop Support- Dist
000-026-081	Spring Post Sleeve - Dist	070-006-087	Sleeve Pivot Trip - Dist
000-026-251	Roller Screw & Star Washer - Dist & Bin	070-006-103	Support Guide LH - Dist 
000-026-865	Thrust washer 1/4 x 7/8 - Dist & Ratchet	070-006-104	Support Guide RH - Dist 
000-028-267	Nut Distributor Head - Dist	070-006-105	Tube Asm Belt Tightener - Dist
022-610-004	Fixed Orientor Pan Kit - One Pinspotter 	070-006-106	Bracket Tracking - Dist
022-090-018	Fixed Orientor Pan 8290 Adapter Kit	070-006-107	Tube Belt Tightener - Dist
070-001-857	Nylon Roller - Dist & Table Drive	070-006-108	Spacer Roller Asm - Dist
070-006-004	Distributor Tube - Dist	070-006-109	Link Tension Roller Asm - Dist
070-060-011	Pulley Asm - Dist	070-006-111	Sleeve Spring Post- Dist
070-006-013	Guide Bin - Dist	070-006-116	Stud Clamp Carriage - Dist & Shuttle
070-006-014	Shaft Trip Arm Pivot - Dist	070-006-117	Concentric Bearing Grooved Blue - Dist 
070-006-015	Trip Arm Asm RH - Dist	070-006-118	Eccentric Bearing Grooved Blue - Dist 
070-006-016	Trip Arm Asm LH - Dist	070-006-121	Washer Clutch - Dist
070-006-019	Spring Collar Carriage Asm - Dist	070-006-124	Clutch Nut - Dist
070-006-021	Tube Asm Front - Dist	070-006-125	Worm Adjusting - Dist
070-006-022	Tube Asm Middle - Dist	070-006-126	Friction Disc - Dist
070-006-028	Rocker Arm Trip Kit- Dist	070-006-128	Spring Asm - Dist
070-006-029	Link Connecting - Dist	070-006-130	Clutch Drive Plate - Dist
070-006-034	Super Spring Linear - Dist 	070-006-137	Belt Guard Carriage Asm- Dist
070-006-0340	Original Spring Linear - Dist	070-006-139	Spacer Inner-Dist
070-006-035	Spring Torsion Trip Arm - Dist 	070-006-140	Spacer Outer- Dist
070-006-036	Belt Lacing Uni-Bar Strip (4 belts) - Dist	070-006-142	Bumper - Multi Position
070-006-037	Lacing Pin Strip (4 belts) - Dist	070-006-144	Orientor Pan Zinc Plated - Dist
070-006-042	Adjustable Belt Runner - Dist 	070-006-149	Index Cam - Dist
070-006-049	Shaft Arm - Dist	070-006-201	Distributor Belt Riser - Dist 
070-006-051	Distributor Arm - Dist	070-006-659	Shaft Trip Rocker Asm - Dist
070-006-055	Carriage Casting Front - Dist	070-006-661	Trip Rocker Arm - Dist
070-006-061	Shaft Cam Support- Dist	070-006-666	Pulley Dist Belt Drive - Dist
070-006-066	Rod End Female - Dist	070-006-667	Trip Casting- Dist
070-006-067	Rod Safety Link - Dist	070-006-668	Please refer to: 070009868
070-006-068	Support Spring-Dist 	070-006-676	Sleeve Dist Drive - Dist
070-006-069	Nut Special Drive Arm - Dist	070-006-679	Bearing Sleeve .752 x.877 x1.66 - Dist
070-006-071	Cam Follower - Dist	070-006-683	Tube Asm Rear - Dist
070-006-073	Thrust Washer - Dist	070-006-685	Pivot Trip Asm - Dist
070-006-075	Needle Bearing 1" Closed End - Dist	070-006-691	Stop Blades Trip Arm - Dist

DB - Distributed Worldwide

DISTRIBUTOR ASSEMBLY

Pinspotter Parts for AMF Equipment

070-006-757GT	Distributor Belt Grip-Trac Asm - Dist 	809-849-205	Hex Head Cap Screw 1/4-20 x 1-1/4 - Hardware
070-006-757RH	Distributor Belt Red Hot Asm - Dist 	809-849-885	Hex Head Cap Screw 1/4-20 x 5-1/2 - Hardware
070-006-757T	Distributor Belt Track Asm - Dist 	809-857-080	Hex Head Cap Screw (Grd 8) 5/16-18 x 1/2 - Hardware
070-006-757W	Waffle Distributor Belt 	810-239-160	Socket Head Cap Screw #10-24 x 1 - Hardware
070-007-376	Thrust Washer - Dist	810-239-240	Socket Head Cap Screw #10-24 x 1-1/2 - Hardware
070-007-586	Side Winder Steel Universal Joint - Dist	813-540-082	Pan Head Screw #10-32 x 1/2 CD - Hardware
070-007-651	Nylon Washer - Dist	831-566-002	Hex Nut 3/8-24 - Hardware
070-008-004	Plastic Universal Joint - Dist	840-039-002	Flex Lock Thin Nut #10-24 - Hardware
070-009-868	Trip Rod Slotted Asm - Dist	840-040-002	Flex Lock Thin Nut #10-32 - Hardware
070-011-170	Trip Rod Solid - Dist 	844-049-002	P Type Nyloc Nut 1/4-20 - Hardware
070-011-171	Cable Asm - Dist	844-050-002	P Type Nyloc Nut 1/4-28 - Hardware
070-011-172	Ball Joint Stud 7/16 - Dist	844-073-002	P Type Nyloc Nut 1/2-13 - Hardware
070-011-173	Ball Joint Stud 9/16 - Dist	900-106-081	Sleeve Bearing .378 x.503 x1/2 - Dist
070-011-910	Orienter Pan Wipe - Dist 	907-000-100	Key #403 HyPro - Dist
610-704-004	Rue Clip - Duraclutch	913-415-090	Spring Pin .094 x 9/16 - Hardware
610-704-005	Pinion & Sleeve Asm - Dist	913-423-160	Spring Pin .125 x 1 - Hardware
610-704-006	Kit Clutch Plate Chrome Asm	913-437-120	Spring Pin .187 x 3/4 - Hardware
610-704-006D	Duraclutch Asm - Dist 	913-437-140	Spring Pin .187 x 7/8 - Hardware
610-704-007	Leather Lining - Duraclutch	913-464-280	Spring Pin .375 x 1 3/4 - Hardware
610-704-008	Spring - Duraclutch	914-037-206	Seloc Pin 3/16 x 1 1/4 - Hardware
610-704-009	Arm Kit - Duraclutch	914-037-206R	R Clip Distributor Drive - Dist Drive 
610-704-013	Nylon Washer - Duraclutch	919-000-600	Internal Retaining Ring #5000-137 - Hardware
610-704-016	Grub Screw	919-004-200	Internal Retaining Ring #5008-212 - Hardware
610-704-017	Clutch Lining (glue needed)	919-005-000	External Retaining Ring #5100-25 - Hardware
610-704-020	Brake Hub/Boss	919-005-300	External Retaining Ring #5100-37 - Hardware
610-704-115	Plastic Clutch Pinion Sleeve	919-005-600	External Retaining Ring #5100-62 - Hardware
612-700-001	Original Style Clutch Kit Asm - Dist	919-006-800	Retaining Ring 5115-37 - Hardware
701-710-098	Spyralign Bearing .313 Bore - Dist	948-745-082	Please refer to: 948-753-102
701-712-097	Spyralign Bearing .375 x .628 - Dist	948-761-112	Washer Wrought 5/16 - Hardware
701-849-124	Metal Concentric Roller 1/4-20 - Dist	948-975-172	Washer 1/2 - Hardware
809-849-100	Hex Head Cap Screw 1/4-20 x 5/8 - Hardware	957-100-002	Lock Washer #10 External Tooth - Hardware
809-849-125	Hex Head Cap Screw 1/4-20 x 3/4 - Hardware		

DISTRIBUTOR DRIVE ASSEMBLY 70'S

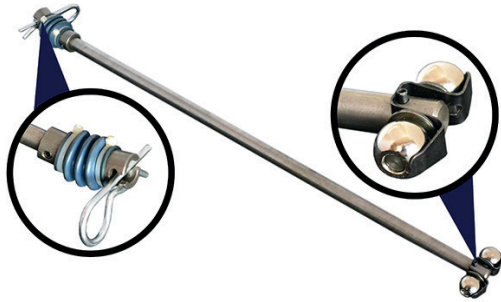

000-024-893
Complete Asm LH Narrow Long



070-006-102
Complete Asm RH Narrow Short

8270



000-022-369



000-022-717



000-024-892



000-026-461



000-027-390



000-029-073



070-006-101



070-007-586

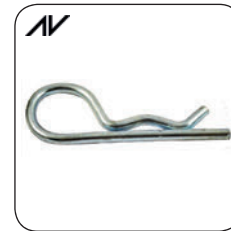

914-037-206R

8270

000-022-369	Long Drive Shaft LH - Dist Drive	070-006-101	Short Drive Shaft RH - Dist Drive
000-022-717	Dowel Pin Narrow - Dist Drive	070-006-102	Shaft Drive Complete Asm RH Narrow Short - Dist Drive
000-024-892	Retainer Uni-Ball Narrow - Dist Drive	070-007-586	Sidewinder Steel Universal Joint - Dist Drive
000-024-893	Drive Shaft Complete Asm LH Narrow Long - Dist Drive	807-358-060	Grub Screw 5/16-24 x 3/8 - Hardware
000-026-461	Uniball Bearing .25x.687 - Dist Drive	913-423-120	Spring Pin .125 x 3/4 - Hardware
000-027-390	Distributor Drive Housing Narrow - Dist Drive	913-437-160	Spring Pin .187 x 1" - Hardware
000-029-073	Washer Uni-Ball - Dist Drive	914-037-206R	R Clip Distributor Drive - Dist Drive

DISTRIBUTOR DRIVE ASSEMBLY 90'S



090-006-102
Complete Asm Wide RH Short
• Easy fit and go



090-006-103
Complete Asm Wide LH Long
• Easy fit and go

8290



000-022-369



000-026-461



000-029-073



070-006-101



070-007-586



090-001-130



090-002-034



722-501-070



908-048-480

8290

000-022-369	Long Drive Shaft LH - Dist Drive	090-002-034	Retainer Wide - Dist Drive
000-026-461	Uniball Bearing .25x .687 - Dist Drive	090-006-102	Drive Shaft Complete Asm Wide RH Short - Dist Drive
000-029-073	Washer Uni-Ball - Dist Drive	090-006-103	Drive Shaft Complete Asm Wide LH Long - Dist Drive
070-006-101	Short Drive Shaft RH - Dist Drive	722-501-070	Wide Spacer Franklin - Dist Drive
070-007-586	Sidewinder Steel Universal Joint - Dist Drive	908-048-480	Dowel Pin 1/4 x 3 Wide - Dist Drive
090-001-130	Drive Housing Wide - Dist Drive	913-423-120	Spring Pin .125 x 3/4 - Hardware
090-002-017	Please refer to: 000-022-369	913-437-160	Spring Pin .187 x 1" - Hardware
090-002-018	Please refer to: 000-006-101	914-037-206R	R Clip Distributor Drive - Dist Drive
090-002-019	Please refer to: 000-026-461		

DB - Satisfaction Guaranteed

BALL LIFT (PBL)

Pinspotter Parts for AMF Equipment



000-021-792



000-022-099



000-024-604



000-024-608



000-024-648



000-024-650



000-024-651



000-024-659



000-024-661



000-024-663RC



000-024-673



000-024-720



000-024-811



000-027-996



000-027-998



000-028-057



000-028-771



000-029-600



000-029-613



000-029-660



000-029-661



070-001-995



070-006-320



070-006-325



070-006-329

BALL LIFT (PBL)

Pinspotter Parts for AMF Equipment



070-006-699



070-006-746



070-006-747



070-006-748

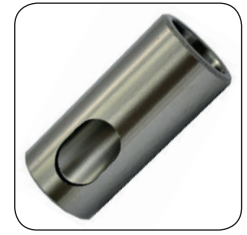

070-006-749



070-007-192



070-007-291



070-008-210



070-008-211



070-008-212



070-008-217



070-008-218



070-011-040



070-011-041



070-011-148



070-011-289



070-011-795SS



070-011-796SS



070-011-797



088-001-233



090-004-520



845-100-000GN

Kickback



000-024-610



000-024-641

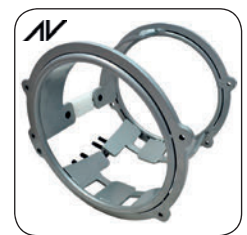

070-011-007

DB - High Performance Bowling Parts

BALL LIFT (PBL)

Pinspotter Parts for AMF Equipment

000-021-792	Washer Frame Adjustment - PBL	070-008-212	Spacer-Ratchet & PBL
000-022-099	Belt V Pitch 112 - Carpet Drive Westinghouse - PBL & Kicker	070-008-217	Spacer - PBL
000-024-603T	PBL Compression Tool - PBL & Tool	070-008-218	Spacer- PBL
000-024-604	Black PBL Belt	070-011-007	Duraring Heavy Duty Ball Door Pair - Kickback 
000-024-608	Retainer Upper - PBL	070-011-040	Nylon Roller - Ratchet, LBS & PBL
000-024-610	Stud Clamp - PBL & Kicker	070-011-041	Belt Tighner -PBL
000-024-641	Stop Bumper - PBL	070-011-148	V-Belt Rudder Primary - PBL & Belt Tensioner
000-024-648	Pivot Pin - PBL	070-011-289	Bracket For Shock Absorber - PBL
000-024-650	Roller Asm - PBL	070-011-440	Please refer to: 000-024-663RC
000-024-651	Lower Link Asm - PBL	070-011-795SS	Silver Steel D Shaft Upper - PBL 
000-024-659	Yoke Lower With Bearings - PBL 	070-011-796SS	Silver Steel D Shaft Lower - PBL 
000-024-661	Super Pulley - PBL 	070-011-797	Ball Bearing D Bore Metal Caged - PBL 
000-024-663	Please refer to: 00024663RC	088-001-233	Premium Grey PBL Belt - PBL 
000-024-663RC	One Piece Blue Rail - Ball Track & PBL 	090-002-450	Please refer to: 000024604
000-024-673	Spring - Dist - PBL & Kicker	090-004-520	V-Belt 114 Carpet Drive Franklin - PBL
000-024-720	Link Asm Upper - PBL	806-265-160	Square Head Cap Screw 3/8-16 x 1 - PBL & Rear Roller
000-024-811	Pulley Solid Asm RH - PBL 	807-265-060	Grub Screw 3/8-16 x 3/8 - Hardware
000-024-812	Pulley Solid Asm LH - PBL	807-265-080	Grub Screw 3/8-16 x 1/2 - Hardware
000-027-996	Cushion Rubber - PBL & Kicker	808-849-565	Flat Head Socket Cap Screw 1/4-20 x 3 1/2 - Hardware
000-027-998	Retainer - PBL & Kicker	809-849-365	Hex Head Cap Screw 1/4-20 x 2-1/4 - Hardware
000-028-057	Retainer Cushion Guide - PBL & Kicker	809-865-165	Hex Head Cap Screw 3/8-16 x 1 - Hardware
000-028-771	Sheave - PBL 	809-865-445	Hex Head Cap Screw 3/8-16 x2-3/4 - Hardware
000-029-600	Belt-V 33 1/2 Ball Rudder, Secondary - PBL	831-566-002	Hex Nut 3/8-24 - Hardware
000-029-613	Rail Ball Elevator - PBL	839-665-002	Flex Lock Nut 3/8-16 - Hardware
000-029-660	Shaft - PBL & Kicker	845-100-000GN	Giant Nut - PBL 
000-029-661	Shock Absorber - PBL & Kicker	845-100-000SP	Giant Spanner - PBL
070-001-995	Upper Yoke With Bearings - PBL 	856-070-002	Flanged Lock Nut 7/16-20 - Hardware
070-006-320	Split Shaft Small - PBL & Kicker	900-110-121	Sleeve Bearing .628 x 3/4 LG - PLB
070-006-325	Split Shaft Long - PBL & Kicker	900-112-161	Sleeve Bearing .753 x 1- Kicker
070-006-329	Shaft Ball Lift 11 to 12 5/8" - PBL	900-112-203	Sleeve Bearing .753 x 1 x 11/4 - PBL & Kickback
070-006-699	Bearing With Snap Ring - PBL & Kicker	900-112-203SL	Self-Lube Front Roller Support - PBL & Kickback
070-006-746	Shaft Lower - PBL & Kicker	900-206-081	Flange Bearing .378 x.688 x1/2 - PBL
070-006-747	Upper Shaft - PBL & Kicker	900-208-161	Flange Bearing - LBS
070-006-748	Spacer - PBL & Kicker	900-208-161SL	Self-Lube Flange Bearing - PBL & Belt Tightner
070-006-749	Clutch Race - PBL & Kicker	919-005-200	External Retaining Ring #5100-31 - Hardware
070-007-192	Washer - Respot Cell & PBL	919-005-600	External Retaining Ring #5100-62 - Hardware
070-007-291	Clutch Bearing NSK .9995 x1.312 x1 03-075 - PBL & Powerlift	919-005-800	External Retaining Ring #5100-75 - Hardware
070-008-210	Sheave Paddle Drive - PBL	948-761-112	Washer Wrought 5/16 - Hardware
070-008-211	Sheave - PBL	948-983-212	Washer 5/8 - Hardware
		951-164-002	Spring Lock Washer 3/8 - Hardware

DB - Satisfaction Guaranteed

BALL TENSIONER & BELT TIGHTENER

Pinspotter Parts for AMF Equipment



000-021-423



000-026-031



000-029-603



000-029-605



000-029-606



000-029-659



070-002-072

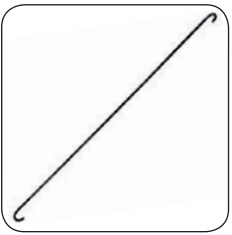

070-011-034

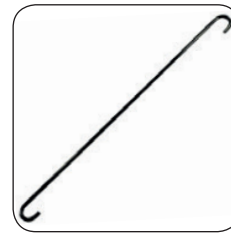

070-011-106



070-011-109



070-011-131



070-011-132



070-011-133



090-002-014



701-320-045



900-110-081



900-110-081SL



900-110-141



900-208-161



900-210-101



900-210-101



919-005-600

DB - Better Value Parts

BALL TENSIONER & BELT TIGHTENER

Pinspotter Parts for AMF Equipment

000-021-423	Collar & Screw 5/8 x 1 1/8 x 1/2 - Shuttle & Belt Tensioner	070-011-132	Belt Tensioner Asm Complete
000-026-031	Belt Tightner Spring - Dist & LBS	070-011-133	Shaft - Belt Tensioner
000-029-603	Shaft Ball Lift Support - Belt Tensioner & Kicker	090-002-014	Idler Shaft ASM - Belt Tensioner
000-029-605	Pivot Shaft - Belt Tensioner & Kicker	701-320-045	Thrust Bearing .628 x 1 x 1/8- Belt Tensioner & Kicker
000-029-606	Pivot Shaft Short PBL - Belt Tensioner & Kicker	900-110-081	Please refer to: 900-110-081SL
000-029-659	Hanger Arm Asm - Belt Tensioner & Kicker	900-110-081SL	Self-Lube Bearing Sleeve - Dist 
070-002-072	Idler Shaft - Belt Tightener	900-110-141	Sleeve Bearing .628 x.878 x7/8 - Kicker
070-011-034	Extension Rod - PBL	900-208-161	Flange Bearing - LBS
070-011-106	Spring Extension - Belt Tensioner	900-210-101	Flange Bearing .628 x 5/8 - Belt Tensioner
070-011-109	Spring Clip - Belt Tensioner	919-005-600	External Retaining Ring #5100-62 - Hardware
070-011-131	Pulley Weldment - Belt Tensioner & PBL		

LIGHT BALL SENSOR

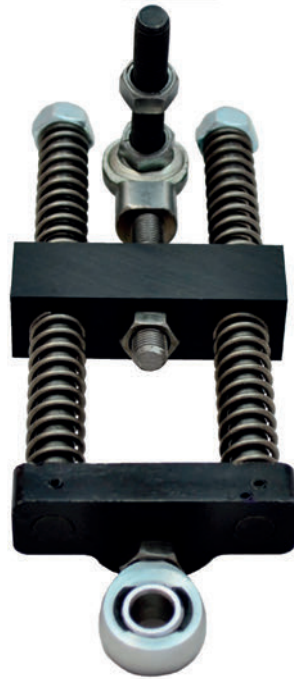

- AV** 070-011-015
 LiteBall Sensor Assembly - LBS
- Less moving parts
 - Easy set up
 - Easy servicing

LiteBall Sensor



070-011-001



070-011-003



070-011-004



070-011-010

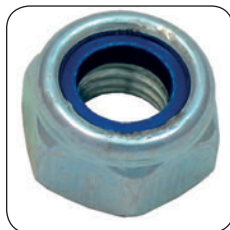

070-011-011



070-011-012



070-011-014

LiteBall Sensor

070-011-001 Right Angle Road End Nut - LiteBall Sensor, LBS

070-011-003 Right Angle Screw Nut - LiteBall Sensor, LBS

070-011-004 Spring Stop Lock Nut - LiteBall Sensor, LBS

070-011-010 Rod End Nut - LiteBall Sensor, LBS

070-011-011 Spring Stop Lock Nut - LiteBall Sensor, LBS

070-011-012 Right Angle Bolt - LiteBall Sensor, LBS

070-011-014 Block - LiteBall Sensor, LBS

070-011-015 LiteBall Sensor Assembly - LBS **AV**

DB - Developed in the United Kingdom

LIGHT BALL SENSOR

Pinspotter Parts for AMF Equipment



000-021-423



000-021-427



000-024-616



000-026-031



000-026-446



000-027-264



000-029-611



070-011-040

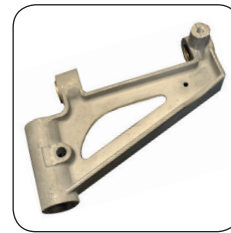

070-011-066



070-011-067



070-011-068



070-011-077



070-011-079



070-011-096



070-011-097



070-011-099



070-011-100



070-011-105



070-011-107



070-011-108



070-011-121



070-011-122



070-011-123



070-011-124



070-011-146

DB - Distributed Worldwide

LIGHT BALL SENSOR

Pinspotter Parts for AMF Equipment



070-011-147



070-011-225



070-011-273



070-011-299



070-011-319



070-011-406



070-011-407



070-011-418



070-011-626



090-005-250



610-704-002



722-971-522



722-985-512



802-865-996



900-205-081



900-208-091



907-000-900

LIGHT BALL SENSOR

Pinspotter Parts for AMF Equipment

000-021-423	Collar & Screw 5/8 x 11/8 x 1/2 - Shuttle, LBS & Belt Tensioner	070-011-406	Rudder Cam Asm RH - LBS
000-021-427	Flange Bearing .629 x .878 x 1/8 - LBS & Kicker	070-011-407	Rudder Cam Asm LH - LBS
000-024-615	Shaft Ball Door - LBS	070-011-418	Trip Cam - LBS
000-024-616	Stud Clamp - LBS & Kicker	070-011-626	Trip Arm Asm - LBS
000-026-031	Belt Tightner Spring - Dist & LBS	090-005-250	Rod End 3/8 RH - Track Rail
000-026-446	Rod End RH 3/8 Female - Bin, LBS & Track Rail	610-704-002	Cam Follower Asm - Shuttle & Spot
000-027-264	Spacer - LBS	722-971-522	Compression Spring .480 x 7/8 - LBS
000-029-611	Uni-ball Brg Washer - LBS & Kicker	722-985-512	Compression Spring - LBS
070-006-728	Please refer to: 610-704-002	802-865-996	Hex Head Cap Screw 3/8-16 x 9-1/2 - LBS
070-011-040	Nylon Roller - Ratchet & LBS	809-849-145	Hex Head Cap Screw 1/4-20 x 7/8 - Hardware
070-011-066	Rudder Arm Support Asm - LBS	809-857-165	Hex Head Cap Screw 5/16-18 x 1 - Hardware
070-011-067	Rudder Arm Support - LBS	809-857-880	Hex Head Cap Screw 5/16-18 x 5-1/2 - Hardware
070-011-068	Link Weld - LBS	809-865-165	Hex Head Cap Screw 3/8-16 x 1 - Hardware
070-011-077	Trip Finger - LBS	809-865-205	Hex Head Cap Screw 3/8-16 x 1-1/4 - Hardware
070-011-079	Rudder Drive Weldment - LBS	809-865-405	Hex Head Cap Screw 3/8-16 x 2-1/2 - Hardware
070-011-096	Roller- LBS	831-573-002	Hex Nut 1/2-13 - Hardware
070-011-097	Crank Pulley - LBS	835-566-002	Jam Hex Nut 3/8-24 - Hardware
070-011-099	Cam - LBS	838-866-002	P Type Nyloc Nut 3/8-24 - Hardware
070-011-100	Cam Sensor Weldment - LBS	839-565-002	Flex Lock Nut 3/8-16 - Hardware
070-011-105	Roller Asm - LBS	840-065-002	Flex Lock Thin Nut 3/8-16 - Hardware
070-011-107	Trip Arm - LBS	844-049-002	P Type Nyloc Nut 1/4-20 - Hardware
070-011-108	Washer- LBS	844-057-002	P Type Nyloc Nut 5/16-18 - Hardware
070-011-121	Plug- LBS	844-070-002	P Type Nyloc Nut 7/16-20 - Hardware
070-011-122	Rudder Arm - LBS	900-205-081	Flange Bearing .315 x.44 x1/2 - LBS
070-011-123	Rod Asm - LBS	900-208-091	Flange Bearing .503 x.690 x 9/16 - Dist, Bin & LBS
070-011-124	Rod- LBS	907-000-900	Key #910 HyPro - Front End Drive, LBS & Kicker
070-011-146	Ball door Paddle - LBS 	913-448-120	Spring Pin .250 x 3/4 - Hardware
070-011-147	V-Belt Rudder Secondary (1380) - LBS & PBL	919-005-200	External Retaining Ring #5100-31 - Hardware
070-011-225	Crank Adj Plate Weld-LBS	919-005-500	External Retaining Ring #5100-50 - Hardware
070-011-273	Tab- LBS	948-761-112	Washer Wrought 5/16 - Hardware
070-011-299	Brace Sensor - PBL & LBS	948-767-132	Washer 3/8 - Hardware
070-011-319	Rudder Arm Support Bracket - LBS	949-100-002	Washer 3/8 - Hardware

DB - Satisfaction Guaranteed

RATCHET DRIVE ASSEMBLY

Pinspotter Parts for AMF Equipment



000-024-679



000-026-865



070-006-142



070-011-009



070-011-013



070-011-027



070-011-028



070-011-029



070-011-030



070-011-031



070-011-032



070-011-033



070-011-036



070-011-039



070-011-040



070-011-064



070-011-217



907-000-200

RATCHET DRIVE ASSEMBLY

Pinspotter Parts for AMF Equipment

000-024-679	Ball bearing .625 x 1.375 - Dist & Kicker	070-011-036	Bearing & Housing Asm - Ratchet
000-026-865	Thrust washer 1/4 x 7/8 - Dist & Ratchet	070-011-039	Ratchet Complete Asm
070-006-142	Bumper - Multi Position	070-011-040	Nylon Roller - Ratchet
070-011-009	Please refer to: 070-011-036	070-011-064	V-Belt #1450 Motor To Pulley - Ratchet & PBL
070-011-013	Crank Weldment - Ratchet	070-011-217	Ratchet Arm Weldment - Ratchet
070-011-027	Ratchet Shaft - Ratchet	809-849-205	Hex Head Cap Screw 1/4-20 x 1-1/4 - Hardware
070-011-028	Washer - Ratchet	838-866-002	P Type Nyloc Nut 3/8-24 - Hardware
070-011-029	Ratchet Nut - Ratchet	907-000-200	Key #404 HyPro - Shuttle & Ratchet
070-011-030	Roller - Ratchet	919-000-600	Internal Retaining Ring #5000-137 - Hardware
070-011-031	Spacer - Ratchet	919-005-200	External Retaining Ring #5100-31 - Hardware
070-011-032	Spring - Ratchet	919-005-800	External Retaining Ring #5100-75 - Hardware
070-011-033	Pulley - Ratchet	948-767-132	Washer 3/8 - Hardware

OLD STYLE KICKER BALL LIFT

Pinspotter Parts for AMF Equipment



000-021-407



000-022-063



000-022-080



000-022-092



000-022-099



000-024-673



000-024-679



000-025-638



000-028-771



000-028-864



000-028-865



000-029-601



000-029-611



000-029-614



000-029-959

Pinspotter Parts for AMF Equipment

000-021-407 Idler Arm Asm RH - Kicker

000-022-063 Sheave Reduction Pulley - Kicker

000-022-080 Rubber Roller - Kicker

000-022-092 Crank Plate Weldment - Kicker

000-022-099 Belt V Pitch 112 - Carpet Drive Westinghouse - PBL & Kicker

000-024-673 Spring - Dist - PBL & Kicker

000-024-679 Ball bearing .625 x 1.375 - Dist & Kicker

000-025-638 Rubber Bumper 3/16 - Kicker

000-028-771 Sheave - PBL

000-028-864 Belt V-Pitch - Kicker

000-028-865 Belt V-Pitch - Kicker

000-029-601 Spring - Kicker

000-029-611 Uni-ball Brg Washer - LBS & Kicker

000-029-614 Unibal Bearing 3/8 ID x 1.00 OD - Bin & Kicker

000-029-959 Pad Filler Asm - Kicker

808-957-160 Flat Head Socket Cap Screw With Patch 5/16-18 x 1 - Hardware

809-849-145 Hex Head Cap Screw 1/4-20 x 7/8 - Hardware

809-857-205 Hex Head Cap Screw 5/16-18 x 1-1/4 - Hardware

809-865-245 Hex Head Cap Screw 3/8-16 x 1-1/2 - Hardware

809-865-405 Hex Head Cap Screw 3/8-16 x 2-1/2 - Hardware

839-665-002 Flex Lock Nut 3/8-16 - Hardware

919-005-600 External Retaining Ring #5100-62 - Hardware

948-761-112 Washer Wrought 5/16 - Hardware

DB - Developed in the United Kingdom

TRACK RAIL ASSEMBLY

Pinspotter Parts for AMF Equipment

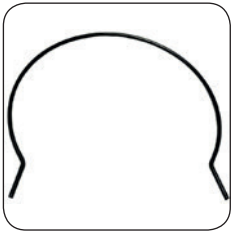

000-021-814

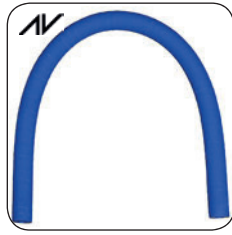

000-024-663RC



000-024-666



000-024-668



000-026-446



070-002-984

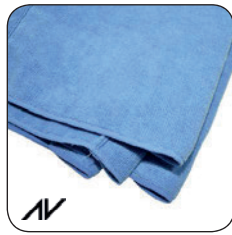

070-004-669



070-004-670



070-011-048



070-011-063



070-011-218



088-001-230



088-001-230D



090-005-250



900-210-161

Pinspotter Parts for AMF Equipment

000-021-814	Wiper Ring - PBL	088-001-230	Thimble Ball Guide - PBL Rail Track
000-024-663RC	One Piece Blue Rail - Ball Track	088-001-230D	Dura Thimble Guides
000-024-666	Track Rail Weldment - PBL	090-005-250	Rod End 3/8 RH - Track Rail
000-024-668	Track Support Bracket - Track	808-857-280	Screw FSH 5/16-18 x 13/4 - Hardware
000-026-446	Rod End RH 3/8 Female - Bin & Track Rail	809-865-165	Hex Head Cap Screw 3/8-16 x 1 - Hardware
070-002-984	Grip Liner - Ball Track	809-865-992	Hex Head Cap Screw 3/8-16 x 9 - Hardware
070-004-669	Cloth Monster Ball Wiper - PBL	835-566-002	Jam Hex Nut 3/8-24 - Hardware
070-004-670	Dust Trap - PBL	838-866-002	P Type Nyloc Nut 3/8-24 - Hardware
070-011-018	Please refer to: 088-001-230	844-057-002	P Type Nyloc Nut 5/16-18 - Hardware
070-011-048	Rod - PBL & Track Rail	844-065-002	P Type Nyloc Nut 3/8-16 - Hardware
070-011-063	Shaft - Track Rail	900-210-161	Flange Bearing .628 x 1 BZ - PBL
070-011-218	Arm Lever Weldment - PBL Track Rail	948-767-132	Washer 3/8 - Hardware
070-011-440	Please refer to: 000-024-663RC	951-164-002	Spring Lock Washer 3/8 - Hardware

DB - Distributed Worldwide

PIT AREA



- AV** 000-026-753TB
Transband Carpet Belt
- Easy to fit & ready to run
 - Wipe clean oil resistant PVC cover
 - Heavy enough to prevent idling pins
 - Light enough to prevent idling light weight balls

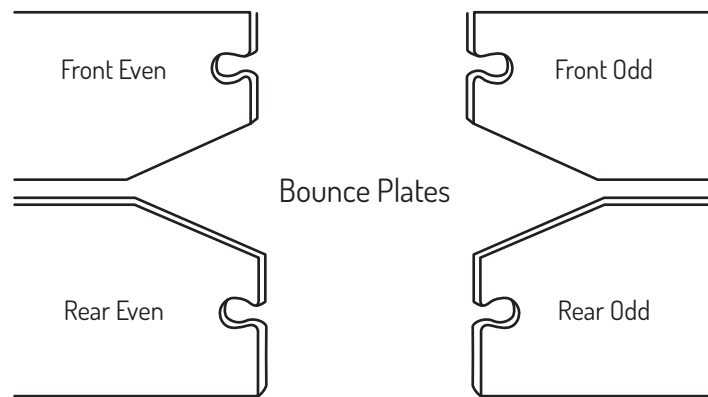

Bounce Plates

- 000-029-925 Armourlite Bounce Plate Front Even
- 000-029-926 Armourlite Bounce Plate Rear Even
- 000-029-899 Armourlite Bounce Plate Front Odd
- 000-029-924 Armourlite Bounce Plate Rear Odd

- 090-005-271 Super Bounce Plate Front Even **AV**
- 090-005-273 Super Bounce Plate Rear Even **AV**
- 090-005-270 Super Bounce Plate Front Odd **AV**
- 090-005-272 Super Bounce Plate Rear Odd **AV**



- AV** 000-024-597SL
Self-Lube Link
- Eliminates lubrication with smooth action



- AV** 000-025-662C
Nyloc Screw Pre Ground
- Flush fit saves time

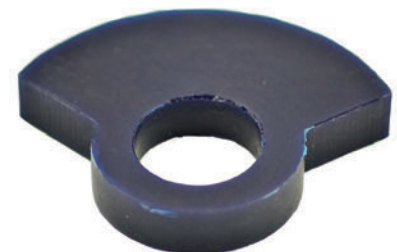

- AV** 000-024-581
Dampener Urethane Front Roller Hinge
- Reduces travel and premature knocking

AV - Add value to your equipment

PIT AREA

Pinspotter Parts for AMF Equipment



000-021-204



000-021-224

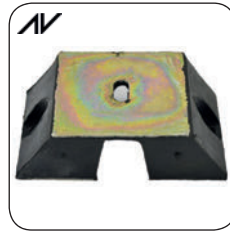

000-021-224HD



000-021-914



000-024-576



000-024-578



000-024-579

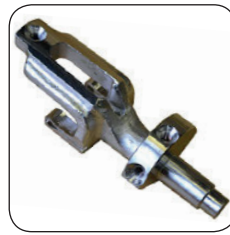

000-024-580



000-024-582



000-024-590



000-024-592



000-024-597



000-025-622

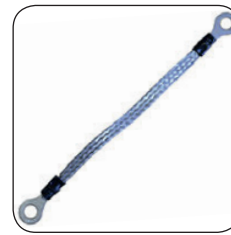

000-025-662

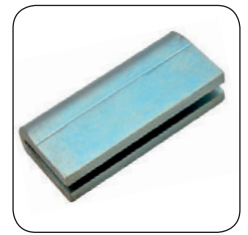

000-027-647



000-029-626



000-029-898



070-002-034



070-002-097



070-007-846



610-704-014



806-265-160

DB - High Performance Bowling Parts

PIT AREA

Kickback



000-021-204



000-022-249
000-027-645
000-027-646
000-029-672



000-022-878



000-022-924



000-022-926



000-023-464
000-023-465



000-023-467



000-024-508



000-024-510



000-024-511



000-024-512

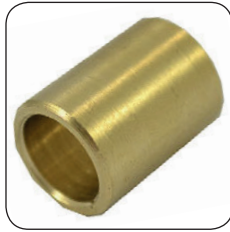

000-024-515



000-024-516



000-025-803



000-025-804



000-026-464



000-027-641



000-027-642



000-029-015



000-029-015K



000-029-317



000-029-640



030-008-660

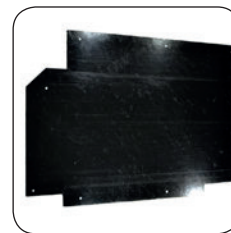

070-002-027



090-004-131

DB - Satisfaction Guaranteed

PIT AREA

Pinspotter Parts for AMF Equipment

000-021-204	Spring Carpet Drive - Kickback	000-027-647	Front Roller Safety Tool - Tool
000-021-224	Dampener Vibration Original - Bounce Plate	000-029-015	Pivot Stud - Kickback
000-021-224HD	Dampener Vibration Heavy Duty - Bounce Plate 	000-029-015K	Pivot Stud Kit - Kickback 
000-021-914	Channel - Bounce Plate	000-029-317	Stop Pin Ejector - Kickback
000-022-249	Bracket Asm LH Even Self-Lube - Kickback 	000-029-626	Support Angle - Bounce Plate
000-022-878	Angle - Kickback	000-029-640	Panel Ball Door - Kickback
000-022-924	Urethane Bearing Support - Kickback 	000-029-672	Bracket Support Asm RH Odd Self-Lube - Kickback 
000-022-926	Retainer Support - Kickback	000-029-898	T-Bar Reinforcing 40.5 - Bounce Plate
000-023-464	Support Weldment RH - Kickback	000-029-899	Armourlite Bounce Plate Front Odd
000-023-465	Support Weldment LH - Kickback	000-029-924	Armourlite Bounce Plate Rear Odd
000-023-467	Bushing .314 x.434x.310 - Kickback	000-029-925	Armourlite Bounce Plate Front Even
000-024-508	Pin Ejector Asm RH & LH - Kickback	000-029-926	Armourlite Bounce Plate Rear Even
000-024-510	Bracket Asm LH - Kickback	030-008-660	Kickback Panel - Kickback
000-024-511	Bracket Asm RH - Kickback	070-001-450	Please refer to: 090-004-131
000-024-512	Spring LH Pin Ejector Asm LH - Kickback	070-001-451	Please refer to: 090-004-131
000-024-515	Bushing Long .44 x .56 x 3/4 - Kickback	070-002-027	Panel - Kickback
000-024-516	Bushing Short .44 x .56 x 3/8 - Kickback	070-002-034	70's/90's Rear Roller Asm With Bearings
000-024-576	Front Roller Complete Asm - Front Roller	070-002-097	Sheave Pulley - Carpet Drive & PBL
000-024-578	Front Roller Body - Front Roller	070-007-846	Field Kit Filler Plate FF - Bounce Plate
000-024-579	Roller Hinge - Front Roller	070-007-847	Rubber Fastner - Bounce Plate
000-024-580	Shaft Hinge - Front Roller	090-004-131	Pit Support Universal RH/LH Frt/Bk 82-70 or 90 - Kickback 
000-024-581	Dampener Urethane Front Roller Hinge - Front Roller 	090-005-270	Super Bounce Plate Front Odd 
000-024-582	Link Roller Pin - Front Roller	090-005-271	Super Bounce Plate Front Even 
000-024-590	Ball Bearing .7874 x 1.8504 - Front Roller, Metal caged bearing	090-005-272	Super Bounce Plate Rear Odd 
000-024-592	Hinge Asm - Front Roller	090-005-273	Super Bounce Plate Rear Even 
000-024-597	Bronze Link - Front Roller	090-006-124	Please refer to: 000-026-753TB
000-024-597SL	Self-Lube Link - Front Roller 	610-704-014	Ball Idling Kit - Bounce Plate
000-025-622	Strap Bonding - Bounce Plate	806-265-160	Square Head Cap Screw 3/8-16 x 1 - PBL & Rear Roller
000-025-662	Nyloc Screw - Front Roller	808-849-160	Flat Head Socket Cap Screw 1/4-20 x 1 - Hardware
000-025-662C	Nyloc Screw Pre Ground - Front Roller 	809-849-165	Hex Head Cap Screw 1/4-20 x 1 - Hardware
000-025-803	Roller Pin Ejector - Kickback	809-849-205	Hex Head Cap Screw 1/4-20 x 1-1/4 - Hardware
000-025-804	Shaft Pin Ejector Asm - Kickback	809-849-325	Hex Head Cap Screw 1/4-20 x 2 - Hardware
000-026-464	Bracket Pit - Kickback	809-857-205	Hex Head Cap Screw 5/16-18 x 1-1/4 - Hardware
000-026-753TB	Transband Carpet Belt - Bounce Plate 	844-049-002	P Type Nyloc Nut 1/4-20 - Hardware
000-027-641	Thrust Bearing .752 x 2.75 x .062 - Kickback	844-057-002	P Type Nyloc Nut 5/16-18 - Hardware
000-027-642	Washer - Front Roller & Kickback	913-411-100	Spring Pin .078 x 5/8 - Hardware
000-027-645	Bracket Support Asm LH Self-Lube - Kickback 	948-753-102	Washer 1/4 - Hardware
000-027-646	Bracket Support Asm RH Self-Lube - Kickback 	948-761-112	Washer Wrought 5/16 - Hardware

DB - Better Value Parts

CUSHION ASSEMBLY



AV 000-024-795 / 000-024-796
Cushion Plank HD Laminate LH & RH
• High density sealed blue laminate



AV 000-022-770
Sponge Rubber Cushion Pad
• Higher density heavy foam for increased impact absorption



AV 000-022-821
Cushion Shock Pin Asm
• With R clips & washers for easy fitting



AV 000-024-808
Cushion Rubber LH
• Sheet cut rubber for strength



AV 070-006-761
Cushion Facing
• Heavy duty abrasion resistant



000-028-529
Non-stick urethane rivet
• Soft, non-stick & hard wearing



AV 000-026-445D
Deflector Curtain
• New style hanging design

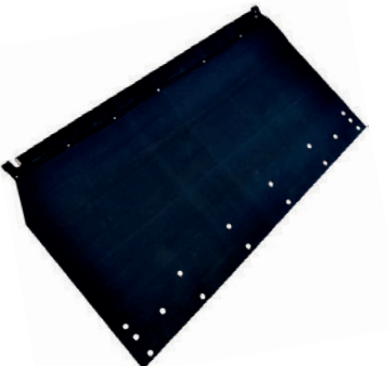

000-026-445
Pin Curtain
• Old style glued, stitched and riveted



AV 022-610-007
Easy Nut Kit - Cushion
• Quick Change

CUSHION ASSEMBLY

Pinspotter Parts for AMF Equipment



000-021-431



000-022-822



000-022-823



000-022-824



000-022-828



000-023-621



000-024-534



000-024-801



000-024-807



000-026-043

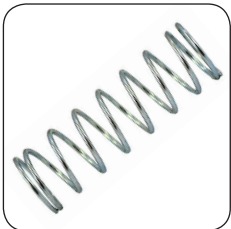

070-001-389



070-001-396



070-001-432



070-002-050



070-002-252



070-005-610

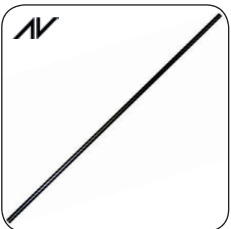

070-011-288



721-502-005

Kickback



000-000-203ASM



000-022-300



000-022-788

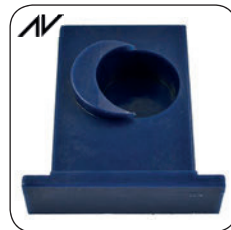

000-022-794
000-022-795









070-011-286

DB - Developed in the United Kingdom

CUSHION ASSEMBLY

Pinspotter Parts for AMF Equipment

000-000-203ASM	Quick Release RH & LH Asm - Cushion 	000-028-519	Please refer to: 000-028-529
000-021-431	Spring Cushion Roller - Cushion, Shock & Solenoid	000-028-529	Non-Stick Urethane Rivet - Cushion
000-021-992	Blue Urethane Grommet - Bin & Pin Elevator	070-001-389	Spring - Curtain Latch & Cushion
000-022-300	Shield Cushion Block - Kickback	070-001-396	Pin Curtain Latch - Curtain
000-022-770	Sponge Rubber Cushion Pad - Cushion 	070-001-432	Rubber Pad Asm - Cushion
000-022-788	Support Box - Kickback	070-002-050	Tube Weldment Hanger RH - Cushion
000-022-794	Block Support Urethane RH - Kickback 	070-002-252	Tube Weldment Hanger LH - Cushion
000-022-795	Block Support Urethane LH - Kickback 	070-005-610	Blue Link Curtain - Cushion
000-022-821	Cushion Shock Pin Asm - Cushion 	070-006-761	Cushion Facing Heavy Duty - Cushion 
000-022-822	Sleeve - Cushion Shock	070-011-286	Curtain Rod Support - Kickback 
000-022-823	Shock Absorber With Collar - Cushion	070-011-288	Extra Strong Curtain Rod - Cushion 
000-022-824	Shock Absorber Complete Asm - Cushion	721-502-005	Rubber Bushing - Cushion Shock 
000-022-828	Bracket Shock Switch Mechanism - Motor Bracket & Cushion	808-865-320	Flat Head Socket Cap Screw 3/8-16 x 2 - Hardware
000-023-621	Lever Cushion Asm Switch - Motor Bracket & Cushion	808-865-400	Flat Head Socket Cap Screw 3/8-16 x2 1/2 - Hardware
000-024-534	Ear Hanger - Cushion	809-857-125	Hex Head Cap Screw 5/16-18 x 3/4 - Hardware
000-024-795	Cushion Plank HD Laminate LH 	839-665-002	Flex Lock Nut 3/8-16 - Hardware
000-024-796	Cushion Plank HD Laminate RH 	844-057-002	P Type Nyloc Nut 5/16-18 - Hardware
000-024-801	Plank Washer - Cushion	913-431-160	Spring Pin .156 x 1 - Hardware
000-024-807	Cushion Rubber RH - Cushion	913-437-240	Spring Pin .187 x 1 1/2 - Hardware
000-024-808	Cushion Rubber LH - Cushion 	948-975-172	Washer 1/2 - Hardware
000-026-043	Micro Switch Big Tip - Bin & Cushion	951-164-002	Spring Lock Washer 3/8 - Hardware
000-026-445	Pin Curtain, Glued, Stitched & Riveted - Cushion	963-600-002	X - Washer 1/4 9000-16 - Hardware
000-026-445D	Deflector Curtain - Cushion 		

DB - Distributed Worldwide

PIN WHEEL ASSEMBLY 70'S

8270



000-020-855



000-021-211N



000-021-992



000-022-222



000-023-673



000-026-032



000-027-014



000-028-362



000-029-068



070-002-005



070-006-030



070-006-044



070-006-046



070-006-047



070-006-099



070-007-357



070-008-449

PIN WHEEL ASSEMBLY 70'S

Pinspotter Parts for AMF Equipment

000-020-855	Ring Tube Weldment - Pin Elevator	070-007-357	Channel Support Weld- Pin Elevator
000-021-211N	Nylon Roller - Pin Elevator 	070-008-449	Spacer Dist Support-Pin Elevator
000-021-992	Blue Urethane Grommet - Bin & Pin Elevator 	809-849-125	Hex Head Cap Screw 1/4-20 x 3/4 - Hardware
000-022-222	Mounting Bracket Pin Elevator Guard - Pin Elevator	809-857-165	Hex Head Cap Screw 5/16-18 x 1 - Hardware
000-023-673	Pin Elevator Drive Pulley - Motor	809-857-405	Hex Head Cap Screw 5/16-18 x 2-1/2 - Hardware
000-026-032	Lateral Drive Spring - Motor Bracket	809-858-085	Hex Head Cap Screw 5/16-24 x 1/2 - Hardware
000-027-014	Pin Wheel Bolt 1/4-28X7/8 - Pin Elevator	809-858-125	Hex Head Cap Screw 5/16-24 x 3/4 - Hardware
000-028-362	Bumper Urethane Plug - Pin Elevator	809-865-725	Hex Head Cap Screw 3/8-16 x 4-1/2 - Hardware
000-029-068	Rubber Mount - Pin Elevator	831-566-002	Hex Nut 3/8-24 - Hardware
070-002-005	V-Belt Pin Wheel - Pin Elevator	834-557-002	Hex Nut 5/16-18 - Hardware
070-006-030	Spring Safety Link - Dist & Pin Elevator	844-049-002	P Type Nyloc Nut 1/4-20 - Hardware
070-006-044	Spring Post Nut 3/8-16-Pin Elevator	844-057-002	P Type Nyloc Nut 5/16-18 - Hardware
070-006-046	Rod End Support - Pin Elevator & Shuttle	913-437-280	Spring Pin .187 x 1 3/4 - Hardware
070-006-047	Tube Support Safety Link - Pin Elevator	948-761-112	Washer Wrought 5/16 - Hardware
070-006-098	Rail RH Machine - Pin Elevator	948-767-132	Washer 3/8 - Hardware
070-006-099	Rail LH Machine - Pin Elevator		

PIN WHEEL ASSEMBLY 90'S



090-007-327ASM
 Roller Bearing Asm - Pin Elevator
 • Designed to remove pin wheel play
 • Fitted with bearing for improved motion
 • Machined from high density polyethylene

8290



000-021-992



000-026-032



000-028-362



000-029-068



070-006-044



070-006-047



070-006-099



070-008-449



090-002-065



090-003-116



090-004-055



090-005-108



090-005-256



938-523-050

DB - Satisfaction Guaranteed

PIN WHEEL ASSEMBLY 90'S

Pinspotter Parts for AMF Equipment

000-021-992	Blue Urethane Grommet - Bin & Pin Elevator 	090-007-327ASM	Roller Bearing Asm - Pin Elevator
000-026-032	Lateral Drive Spring - Motor Bracket & Pin Elevator	809-857-325	Hex Head Cap Screw 5/16-18 x 2 - Hardware
000-028-362	Bumper Urethane Plug - Pin Elevator	809-857-405	Hex Head Cap Screw 5/16-18 x 2-1/2 - Hardware
000-029-068	Rubber Mount - Pin Elevator	809-865-725	Hex Head Cap Screw 3/8-16 x 4-1/2 - Hardware
070-006-044	Spring Post Nut 3/8-16-Pin Elevator	831-566-002	Hex Nut 3/8-24 - Hardware
070-006-047	Tube Support Safety Link - Pin Elevator	834-527-002	Hex Nut #6-32 - Hardware
070-006-098	Rail RH Machine - Pin Elevator	844-057-002	P Type Nyloc Nut 5/16-18 - Hardware
070-006-099	Rail LH Machine - Pin Elevator	844-065-002	P Type Nyloc Nut 3/8-16 - Hardware
070-008-449	Spacer Dist Support-Pin Elevator	938-523-050	Pop Rivet Open End 1/8 x 5/16 - Hardware
090-002-065	Please refer to: 070-002-005	948-761-112	Washer Wrought 5/16 - Hardware
090-003-116	Spacer - Pin Elevator	948-767-132	Washer 3/8 - Hardware
090-004-055	Washer - Pin Elevator	951-156-002	Spring Lock Washer 5/16 - Hardware
090-005-108	Pin Wheel Strip Green - Pin Elevator 	951-181-002	Spring Lock Washer 5/8 - Hardware
090-005-256	Rod End Support - Pin Elevator & Shuttle		

BUMPER ASSEMBLY



AV 049-000-000
Auto Bumper Upgrade LH/RH - Bumper Upgrade
• Thicker Stainless Steel with no twist

AMF Bumper Upgrade



049-007-001



049-007-002



049-007-003



049-007-007



049-007-008



049-007-075

AMF Bumper Upgrade

049-000-000	Auto Bumper Upgrade LH/RH - Bumper Upgrade AV	049-007-007	Spring - Bumper Upgrade
049-007-001	Channel - Bumper Upgrade	049-007-008	Shackle Connector - Bumper Upgrade
049-007-002	Bracket Lever - Bumper Upgrade	049-007-075	2 Piece Common Bumper Rail Grey - AMF Bumper
049-007-003	Pivot Bush - Bumper Upgrade		

AV - Add value to your equipment

BUMPER ASSEMBLY



AV 049-007-081HD
Heavy Duty Upright Bracket Assembly
• Durable upgrade to original



AV 049-007-091G
Bumper Rail RH Solid Frt Section - AMF Bumper - Grey
• Durable solid bumper rail



AV 049-007-092G
Bumper Rail LH Solid Frt Section - AMF Bumper - Grey
• Durable solid bumper rail

Parts for AMF Bumper Systems

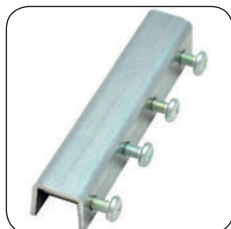

049-007-029



049-007-064



049-007-065



049-007-068



049-007-081



049-007-093



708-803-006

Parts for AMF Bumper Systems

049-000-002 Hardware 100X14X2mm - Bumper Upgrade

049-007-010 Bumper Clevis Pin Kit - Bumper Upgrade

049-007-029 Connection Bracket ASM - Bumper

049-007-064 End Cap LH - AMF Bumper

049-007-065 End Cap RH - AMF Bumper

049-007-068 Bumper Return Spring - AMF Bumper

049-007-081 Upright Bracket improved with Bearing - AMF Bumper

049-007-081HD Heavy Duty Upright Bracket Assembly **AV**

049-007-091G Bumper Rail RH Solid Frt Section - AMF Bumper - Grey **AV**

049-007-092G Bumper Rail LH Solid Frt Section - AMF Bumper - Grey **AV**

049-007-093 H Bracket Kit - AMF Bumper **AV**

049-007-178 Please refer to: 049-007-068

708-803-006 Air Cylinder A/B - Durabowl Auto Bumpers

BALL RETURN

Powerlift / C90 / Profile / Options / Spectrum



234-001-147

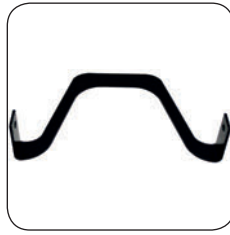

250-000-000



250-001-009



250-001-011

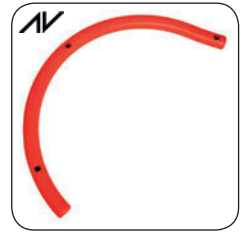

250-001-012



250-001-013



250-001-015

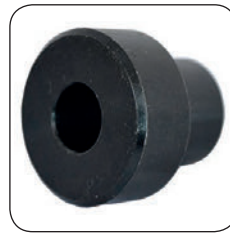

250-001-021



250-001-023



250-001-027



250-001-034



250-001-037

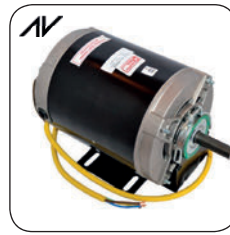

250-001-040



250-001-046



250-001-047

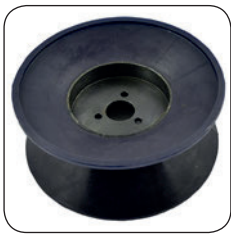

250-001-051



250-001-051R



250-001-053

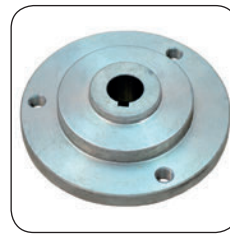

250-001-060

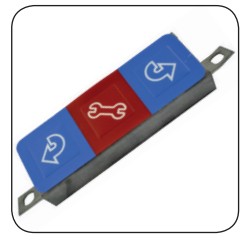

250-001-205



250-001-230



250-001-232



250-001-233



250-001-234

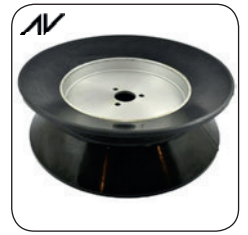

250-001-236

DB - Satisfaction Guaranteed

BALL RETURN

Powerlift / C90 / Profile / Options / Spectrum



250-001-537



250-001-777

250-004-019
250-004-039250-004-036
250-004-037

701-504-012



250-001-435



702-504-013



702-504-014

Powerlift / C90 / Profile / Options / Spectrum

234-001-147	Flat Belt (Goodyear) - Spectrum	250-001-233	Shaft Key CBL-13 - Powerlift
250-000-000	Safety Brace - Powerlift	250-001-234	Clutch Sleeve CBL-11 - Powerlift
250-001-000	Ball Rack Repair Kit - Options & Profile	250-001-236	V-Wheel Options - Powerlift
250-001-009	Upper Shaft SA CBL-A9 - Powerlift	250-001-435	Spin Out Rail - Powerlift
250-001-011	Idler - Powerlift	250-001-537	Single Groove Cast Iron Sheave 1.75 - Powerlift
250-001-012	Upper Track Red C Rail - Powerlift	250-001-777	C90 Fan 220V (Square) - Powerlift
250-001-013	Lower Track Blue C Rail - Powerlift	250-004-019	Lower Side Wear Strip Options - Powerlift
250-001-015	Lower Shaft SA CBL-A8 - Powerlift	250-004-036	Lower Guide Wear Strip Options - Powerlift
250-001-021	Idler Saft - Powerlift	250-004-037	Upper Guide Wear Strip Options - Powerlift
250-001-023	Spacer Bracket CBL-12 - Powerlift	250-004-039	Upper Side Wear Strip Options - Powerlift
250-001-027	Idler Nut - Powerlift	702-504-012	Belt-V Type A 69.3 PD - Spectrum
250-001-034	Rail Spacer CBL-47 - Powerlift	702-504-013	Belt-V Type A 35.3 PD - Spectrum
250-001-037	Premium Double V-Belt AA90 - Powerlift	702-504-014	Belt-V Type A 34.3 PD - Spectrum
250-001-037G	Please refer to: 250001037	808-549-160	Button Head Cap Screw 1/4-20 x 1 - Hardware
250-001-040	Ball Return Motor - Powerlift	808-557-360	Button Head Cap Screw 5/16 -18 x 2 1/2 - Hardware
250-001-046	Grommet 60	809-849-145	Hex Head Cap Screw 1/4-20 x 7/8 - Hardware
250-001-047	Bushing	809-849-165	Hex Head Cap Screw 1/4-20 x 1 - Hardware
250-001-051	V-Wheel Blue - Powerlift	809-857-125	Hex Head Cap Screw 5/16-18 x 3/4 - Hardware
250-001-051R	V-Wheel Red - Powerlift	809-857-165	Hex Head Cap Screw 5/16-18 x 1 - Hardware
250-001-053	Clutch Housing With Bearing CBES - Powerlift	809-857-205	Hex Head Cap Screw 5/16-18 x 1-1/4 - Hardware
250-001-060	Hub (CBL-6) - Powerlift	809-865-245	Hex Head Cap Screw 3/8-16 x 1-1/2 - Hardware
250-001-085	Please refer to: 250001011	839-057-002	Please refer to: 844-057-002
250-001-108	Idler Stud CBL-77 - Powerlift	844-073-002	P Type Nyloc Nut 1/2-13 - Hardware
250-001-205	Tenth Frame Switch Asm - Powerlift	948-761-112	Washer Wrought 5/16 - Hardware
250-001-230	Hub Shaft CBL-4 - Powerlift	951-148-002	Spring Lock Washer 1/4 - Hardware
250-001-232	Bearing Spacer CBL-9 - Powerlift	951-156-002	Spring Lock Washer 5/16 - Hardware

DB - Better Value Parts

802-865-996	Hex Head Cap Screw 3/8-16 x 9-1/2 - LBS	809-857-205	Hex Head Cap Screw 5/16-18 x1-1/4 - Hardware
806-265-160	Square Head Cap Screw 3/8-16 x1 - PBL & Rear Roller	809-857-245	Hex Head Cap Screw 5/16-18 x1-1/2 - Hardware
807-265-060	Grub Screw 3/8-16 x 3/8 - Hardware	809-857-325	Hex Head Cap Screw 5/16-18 x 2 - Hardware
807-265-080	Grub Screw 3/8-16 x 1/2 - Hardware	809-857-405	Hex Head Cap Screw 5/16-18 x 2-1/2 - Hardware
807-357-060	Grub Screw 5/16-18 x 3/8 - Hardware	809-857-880	Hex Head Cap Screw 5/16-18 x 5-1/2 - Hardware
807-358-060	Grub Screw 5/16-24 x 3/8 - Hardware	809-858-085	Hex Head Cap Screw 5/16-24 x 1/2 - Hardware
807-358-060W	Grub Screw - Drive Housing Wide	809-858-125	Hex Head Cap Screw 5/16-24 x 3/4 - Hardware
807-650-050	Grub Screw 1/4-28 x 5/16 Set Screw - Hardware	809-858-165	Hex Head Cap Screw 5/16-24 x 1 - Hardware
808-549-080	Button Head Cap Screw 1/4-20 x 1/2 - Hardware	809-865-125	Hex Head Cap Screw 3/8-16 x 3/4 - Hardware
808-549-160	Button Head Cap Screw 1/4-20 x 1 - Hardware	809-865-165	Hex Head Cap Screw 3/8-16 x 1 - Hardware
808-549-240	Button Head Cap Screw 1/4-20 x1-1/2 Hardware	809-865-205	Hex Head Cap Screw 3/8-16 x 1-1/4 - Hardware
808-557-140	Button Head Cap Screw 5/16-18 x 7/8 - Hardware	809-865-245	Hex Head Cap Screw 3/8-16 x 1-1/2 - Hardware
808-557-160	Button Head Cap Screw 5/16-18 x 1 - Hardware	809-865-285	Hex Head Cap Screw 3/8-16 x 1-3/4 - Hardware
808-557-240	Button Head Cap Screw 5/16-18 x 1-1/2 - Hardware	809-865-365	Hex Head Cap Screw 3/8-16 x 2-1/4 - Hardware
808-640-121	Cap Head Patched #10-32 x 3/4 - Hardware	809-865-405	Hex Head Cap Screw 3/8-16 x 2-1/2 - Hardware
808-640-141	Cap Head Patched #10-32 x 7/8 - Hardware	809-865-445	Hex Head Cap Screw 3/8-16 x2-3/4 - Hardware
808-849-160	Flat Head Socket Cap Screw 1/4-20 x 1 - Hardware	809-865-485	Hex Head Cap Screw 3/8-16 x 3 - Hardware
808-849-565	Flat Head Socket Cap Screw 1/4-20 x 3 1/2 - Hardware	809-865-565	Hex Head Cap Screw 3/8-16 x 3-1/2 - Hardware
808-857-120	Flat Head Socket Cap Screw 5/16-18 x 3/4 - Hardware	809-865-645	Hex Head Cap Screw 3/8-16 x 4 - Hardware
808-857-160	Flat Head Socket Cap Screw 5/16-18 x 1 - Hardware	809-865-725	Hex Head Cap Screw 3/8-16 x 4-1/2 - Hardware
808-865-320	Flat Head Socket Cap Screw 3/8-16 x 2 - Hardware	809-865-992	Hex Head Cap Screw 3/8-16 x 9 - Hardware
808-865-400	Flat Head Socket Cap Screw 3/8-16 x2 1/2 - Hardware	809-869-245	Hex Head Cap Screw 7/16-14 x1-1/2 - Hardware
808-866-400	Flat Head Socket Cap Screw 3/8-24 x2 1/2 - Hardware	809-869-285	Hex Head Cap Screw 7/16-14 x 1-3/4 - Hardware
808-957-160	Flat Head Socket Cap Screw With Patch 5/16-18 x 1 - Hardware	809-869-325	Hex Head Cap Screw 7/16-14 x 2 - Hardware
809-149-100	Hex Head Cap Screw 1/4-20 x 5/8 With Patch - Hardware	809-869-365	Hex Head Cap Screw 7/16-14 x2-1/4 - Hardware
809-549-120	Button Head Cap Screw 1/4 - 20 x 3/4 - Hardware	809-869-405	Hex Head Cap Screw 7/16-14 x 2-1/2 - Hardware
809-849-085	Hex Head Cap Screw 1/4-20 x1/2 - Hardware	809-869-445	Hex Head 7/16 - 14 x 23/4 - Hardware
809-849-100	Hex Head Cap Screw 1/4-20 x 5/8 - Hardware	809-870-285	Hex Head Cap Screw 7/16-20 x 1-3/4 - Hardware
809-849-125	Hex Head Cap Screw 1/4-20 x 3/4 - Hardware	809-873-405	Hex Head Cap Screw 1/2-13 x 2-1/2 - Hardware
809-849-145	Hex Head Cap Screw 1/4-20 x 7/8 - Hardware	810-233-080	Socket Head Cap Screw #8-32 x 1/2 - Hardware
809-849-165	Hex Head Cap Screw 1/4-20 x 1 - Hardware	810-233-120	Socket Head Cap Screw #8-32 x 3/4 - Hardware
809-849-205	Hex Head Cap Screw 1/4-20 x 1-1/4 - Hardware	810-239-060	Socket Head Cap Screw #10-24 x 3/8 - Hardware
809-849-245	Hex Head Cap Screw 1/4-20 x 1-1/2 - Hardware	810-239-120	Socket Head Cap Screw #10-24 x 3/4 - Hardware
809-849-285	Hex Head Cap Screw 1/4-20 x 1-3/4 - Hardware	810-239-160	Socket Head Cap Screw #10-24 x 1 - Hardware
809-849-325	Hex Head Cap Screw 1/4-20 x 2 - Hardware	810-239-240	Socket Head Cap Screw #10-24 x 1-1/2 - Hardware
809-849-365	Hex Head Cap Screw 1/4-20 x 2-1/4 - Hardware	810-240-080	Socket Head Cap Screw #10-32 x 1/2 - Hardware
809-849-405	Hex Head Cap Screw 1/4-20 x 2-1/2 - Hardware	810-249-200	Socket Head Cap Screw 1/4-20 x 1-1/4 - Hardware
809-849-605	Hex Head Cap Screw 1/4-20 x 3-3/4 - Hardware	810-250-200	Socket Head Cap Screw 1/4-28 x1 1/4 - Hardware
809-849-885	Hex Head Cap Screw 1/4-20 x 5-1/2 - Hardware	810-250-480	Socket Head Cap Screw - Hardware
809-857-080	Hex Head Cap Screw (Grd 8) 5/16-18 x 1/2 - Hardware	810-257-120	Socket Head Cap Screw 5/16 - 18 x 3/4 - Hardware
809-857-125	Hex Head Cap Screw 5/16-18 x 3/4 - Hardware	810-257-160	Socket Head Cap Screw 5/16-18 x 1 - Hardware
809-857-165	Hex Head Cap Screw 5/16-18 x 1 - Hardware	810-258-100	Socket Head Cap Screw 5/16-24 x 5/8 - Hardware

810-258-160	Socket Head Cap Screw 5/16-24 x 1 - Hardware	840-070-002	Flex Lock Thin Nut 7/16-20 - Hardware
810-258-240	Socket Head Cap Screw 5/16-24 x 1-1/2 - Hardware	843-127-002	Kep Nut Washer #6-32 - Hardware
810-265-160	Socket Head Cap Screw 3/8 - 16 x 11/2 - Hardware	843-133-002	Please refer to: 839-533-002
810-265-240	Socket Head Cap Screw 3/8 - 16 x 11/2 - Hardware	843-140-002	Kep Nut Washer #10-32 - Hardware
810-265-280	Socket Head Cap Screw 3/8-16 x 1-3/4 - Hardware	844-049-002	P Type Nyloc Nut 1/4-20 - Hardware
810-265-400	Socket Head Cap Screw 3/8-16 x 2-1/2 - Hardware	844-050-002	P Type Nyloc Nut 1/4-28 - Hardware
811-015-202	Split Pin 3/32 x 11/4 - Hardware	844-057-002	P Type Nyloc Nut 5/16-18 - Hardware
813-240-890	Pan Head Screw Machine Phillips - Hardware	844-058-002	P Type Nyloc Nut 5/16-24 - Hardware
813-321-062	Pan Head Screw #4-40 x 3/8 CD Truss Head - Hardware	844-065-002	P Type Nyloc Nut 3/8-16 - Hardware
813-540-082	Pan Head Screw #10-32 x 1/2 CD - Hardware	844-069-002	P Type Nyloc Nut 7/16-14 - Hardware
813-933-162	Machine Hex Head Screw #8-32 x 1 CD - Hardware	844-070-002	P Type Nyloc Nut 7/16-20 - Hardware
814-333-122	Machine Hex Head Screw #8-32 x 3/4 - Hardware	844-073-002	P Type Nyloc Nut 1/2-13 - Hardware
830-057-002	Acorn Lock Nut 5/16-18 - Hardware	844-074-002	P Type Nyloc Nut 1/2-20 - Hardware
831-565-002	Hex Nut 3/8-16 - Hardware	844-549-000	Jack Nut 1/4-20 - Hardware
831-566-002	Hex Nut 3/8-24 - Hardware	847-749-007	Insert 1/4 - 20 AKS4-420-260 AVK - Hardware
831-573-002	Hex Nut 1/2-13 - Hardware	856-070-002	Flanged Lock Nut 7/16-20 - Hardware
834-527-002	Hex Nut #6-32 - Hardware	879-849-487	Eyebolt 1/4-20 x 3 - Table
834-549-002	Hex Nut 1/4-20 - Hardware	880-057-002	Dome Nut 5/16 UNC - Hardware
834-557-002	Hex Nut 5/16-18 - Hardware	880-139-120	Screw Sheild 1/4 x 3/8 - Hardware
834-821-000	Hex Nut Brass #4-40 - Hardware	911-015-202	Cotter Pin 3/32 x 11/4 - Hardware
835-549-002	Jam Hex Nut 1/4-20 - Hardware	913-411-100	Spring Pin .078 x 5/8 - Hardware
835-550-002	Jam Hex Nut 1/4-28 - Hardware	913-415-090	Spring Pin .094 x 9/16 - Hardware
835-565-002	Jam Hex Nut 3/8-16 - Hardware	913-415-100	Spring Pin .094 x 5/8 - Hardware
835-566-002	Jam Hex Nut 3/8-24 - Hardware	913-415-120	Spring Pin .094 x 3/4 - Hardware
835-570-002	Jam Hex Nut 7/16-20 - Hardware	913-423-120	Spring Pin .125 x 3/4 - Hardware
835-573-002	Jam Hex Nut 1/2-13 - Hardware	913-423-160	Spring Pin .125 x 1 - Hardware
835-574-002	Jam Hex Nut 1/2-20 - Hardware	913-431-160	Spring Pin .156 x 1 - Hardware
835-582-002	Jam Hex Nut 5/8-18 - Hardware	913-437-100	Spring Pin .187 x 5/8 - Hardware
835-650-002	Jam Hex Nut Left Hand 1/4-28 - Hardware	913-437-120	Spring Pin .187 x 3/4 - Hardware
835-670-002	Jam Hex Nut Left Hand 7/16-20 - Hardware	913-437-140	Spring Pin .187 x 7/8 - Hardware
835-674-002	Jam Hex Nut Left Hand 1/2-20 - Hardware	913-437-160	Spring Pin .187 x 1" - Hardware
838-369-002	Lock Nut Center Punch 7/16-14 - Hardware	913-437-240	Spring Pin .187 x 11/2 - Hardware
838-866-002	P Type Nyloc Nut 3/8-24 - Hardware	913-437-280	Spring Pin .187 x 13/4 - Hardware
839-057-002	Please refer to: 844-057-002	913-448-120	Spring Pin .250 x 3/4 - Hardware
839-533-002	Flex Lock Nut #8-32 - Hardware	913-464-280	Spring Pin .375 x 13/4 - Hardware
839-565-002	Flex Lock Nut 3/8-16 - Hardware	913-464-360	Spring Pin .375 x 2 1/4 - Hardware
839-665-002	Flex Lock Nut 3/8-16 - Hardware	913-464-400	Spring Pin .375 x 2 1/2 - Hardware
840-039-002	Flex Lock Thin Nut #10-24 - Hardware	914-037-206	Seloc Pin 3/16 x 11/4 - Hardware
840-040-002	Flex Lock Thin Nut #10-32 - Hardware	919-000-600	Internal Retaining Ring #5000-137 - Hardware
840-049-002	Flex Lock Thin Nut 1/4-20 - Hardware	919-000-700	Internal Retaining Ring #5000-156 - Hardware
840-065-002	Flex Lock Thin Nut 3/8-16 - Hardware	919-004-200	Internal Retaining Ring #5008-212 - Hardware
840-066-002	Flex Lock Thin Nut 3/8-24 - Hardware	919-005-000	External Retaining Ring #5100-25 - Hardware

919-005-200	External Retaining Ring #5100-31 - Hardware	948-767-132	Washer 3/8 - Hardware
919-005-300	External Retaining Ring #5100-37 - Hardware	948-975-172	Washer 1/2 - Hardware
919-005-400	External Retaining Ring #5100-43 - Hardware	948-983-212	Washer 5/8 - Hardware
919-005-500	External Retaining Ring #5100-50 - Hardware	949-100-002	Washer 3/8 - Hardware
919-005-600	External Retaining Ring #5100-62 - Hardware	950-001-008	Washer Nylon .750 x 1.25 x .080 - Hardware
919-005-800	External Retaining Ring #5100-75 - Hardware	951-148-002	Spring Lock Washer 1/4 - Hardware
919-006-800	Retaining Ring #5115-37 - Hardware	951-148-008	Spring Lock Washer 1/4 - Hardware
919-010-200	Retaining Ring #5133-25 - Hardware	951-156-002	Spring Lock Washer 5/16 - Hardware
919-010-700	Retaining Ring #5133-62 - Hardware	951-164-002	Spring Lock Washer 3/8 - Hardware
937-000-000	Drive Rivet 1/4 x 11/32 - Kickback	951-181-002	Spring Lock Washer 5/8 - Hardware
938-523-050	Pop Rivet Open End 1/8 x 5/16 - Hardware	957-000-002	Lock Washer #6 External Tooth - Hardware
938-537-060	Pop Rivet 3/16 - Hardware	957-100-002	Lock Washer #10 External Tooth - Hardware
945-867-242	Washer 10m - Hardware	963-000-002	X - Washer 3/32 9000-5.4 - Hardware
947-041-100	Please refer to: 948-041-100	963-100-002	X - Washer 3/32 9000-6 - Hardware
947-367-141	Washer Hardened 13/32 x 7/8 - Hardware	963-200-002	X - Washer 1/8 9000-8 - Hardware
948-631-062	Washer 3/16 - Hardware	963-300-002	X - Washer 5/32 9000-10 - Hardware
948-745-082	Please refer to: 948-753-102	963-400-002	X - Washer 3/16 9000-12 - Hardware
948-753-102	Washer 1/4 - Hardware	963-600-002	X - Washer 1/4 9000-16 - Hardware
948-761-112	Washer Wrought 5/16 - Hardware	963-700-002	X - Washer 5/16 9000-20 - Hardware

DB - Satisfaction Guaranteed

Belgium, France, Netherlands, Switzerland & Morocco

Valcke Group
Menenstraat 423
BE - 8560
Wevelgem

Phone: +33 3 66 88 22 00

E-mail: bowling@valckegroup.com

Website: www.valcke-bowling.com

Our approved distributors give you access to local stock and advice

BELGIUM > 056 43 85 55
FRANCE > 03 66 88 22 00
NEDERLAND > 02 08 90 81 65
SUISSE > 021 588 02 66



VALCKE GROUP BVBA
Menenstraat 423
8560 Wevelgem - BELGIUM

www.valcke-bowling.com
bowling@valckegroup.com